

**FLUKE®**

# **1550C/1555**

Insulation Tester

## Users Manual

PN 3593019

April 2010

© 2010 Fluke Corporation. All rights reserved. Printed in USA. Specifications are subject to change without notice. All product names are trademarks of their respective companies.

## LIMITED WARRANTY AND LIMITATION OF LIABILITY

Each Fluke product is warranted to be free from defects in material and workmanship under normal use and service. The warranty period is three years and begins on the date of shipment. Parts, product repairs, and services are warranted for 90 days. This warranty extends only to the original buyer or end-user customer of a Fluke authorized reseller, and does not apply to fuses, disposable batteries, or to any product which, in Fluke's opinion, has been misused, altered, neglected, contaminated, or damaged by accident or abnormal conditions of operation or handling. Fluke warrants that software will operate substantially in accordance with its functional specifications for 90 days and that it has been properly recorded on non-defective media. Fluke does not warrant that software will be error free or operate without interruption.

Fluke authorized resellers shall extend this warranty on new and unused products to end-user customers only but have no authority to extend a greater or different warranty on behalf of Fluke. Warranty support is available only if product is purchased through a Fluke authorized sales outlet or Buyer has paid the applicable international price. Fluke reserves the right to invoice Buyer for importation costs of repair/replacement parts when product purchased in one country is submitted for repair in another country.

Fluke's warranty obligation is limited, at Fluke's option, to refund of the purchase price, free of charge repair, or replacement of a defective product which is returned to a Fluke authorized service center within the warranty period.

To obtain warranty service, contact your nearest Fluke authorized service center to obtain return authorization information, then send the product to that service center, with a description of the difficulty, postage and insurance prepaid (FOB Destination). Fluke assumes no risk for damage in transit. Following warranty repair, the product will be returned to Buyer, transportation prepaid (FOB Destination). If Fluke determines that failure was caused by neglect, misuse, contamination, alteration, accident, or abnormal condition of operation or handling, including overvoltage failures caused by use outside the product's specified rating, or normal wear and tear of mechanical components, Fluke will provide an estimate of repair costs and obtain authorization before commencing the work. Following repair, the product will be returned to the Buyer transportation prepaid and the Buyer will be billed for the repair and return transportation charges (FOB Shipping Point).

THIS WARRANTY IS BUYER'S SOLE AND EXCLUSIVE REMEDY AND IS IN LIEU OF ALL OTHER WARRANTIES, EXPRESS OR IMPLIED, INCLUDING BUT NOT LIMITED TO ANY IMPLIED WARRANTY OF MERCHANTABILITY OR FITNESS FOR A PARTICULAR PURPOSE. FLUKE SHALL NOT BE LIABLE FOR ANY SPECIAL, INDIRECT, INCIDENTAL OR CONSEQUENTIAL DAMAGES OR LOSSES, INCLUDING LOSS OF DATA, ARISING FROM ANY CAUSE OR THEORY. Since some countries or states do not allow limitation of the term of an implied warranty, or exclusion or limitation of incidental or consequential damages, the limitations and exclusions of this warranty may not apply to every buyer. If any provision of this Warranty is held invalid or unenforceable by a court or other decision-maker of competent jurisdiction, such holding will not affect the validity or enforceability of any other provision.

Fluke Corporation  
P.O. Box 9090  
Everett, WA 98206-9090  
U.S.A.

Fluke Europe B.V.  
P.O. Box 1186  
5602 BD Eindhoven  
The Netherlands

To register your product, visit <http://register.fluke.com>.

11/99

**For complete operational instructions, refer to the Users Manual contained on the accompanying CD.**

## LIMITES DE GARANTIE ET DE RESPONSABILITE

La société Fluke garantit l'absence de vices de matériaux et de fabrication de ses produits dans des conditions normales d'utilisation et d'entretien. La période de garantie est de trois ans et prend effet à la date d'expédition. Les pièces, les réparations de produit et les services sont garantis pour un période de 90 jours. Cette garantie ne s'applique qu'à l'acheteur d'origine ou à l'utilisateur final s'il est client d'un distributeur agréé par Fluke, et ne s'applique pas aux fusibles, aux batteries/piles interchangeables ni à aucun produit qui, de l'avis de Fluke, a été malmené, modifié, négligé, contaminé ou endommagé par accident ou soumis à des conditions anormales d'utilisation et de manipulation. Fluke garantit que le logiciel fonctionnera en grande partie conformément à ses spécifications fonctionnelles pour une période de 90 jours et qu'il a été correctement enregistré sur des supports non défectueux. Fluke ne garantit pas que le logiciel ne contient pas d'erreurs ou qu'il fonctionne sans interruption.

Les distributeurs agréés par Fluke appliqueront cette garantie à des produits vendus à leurs clients neufs et qui n'ont pas servi mais ne sont pas autorisés à appliquer une garantie plus étendue ou différente au nom de Fluke. Le support de garantie est offert uniquement si le produit a été acquis par l'intermédiaire d'un point de vente agréé par Fluke ou bien si l'acheteur a payé le prix international applicable. Fluke se réserve le droit de facturer à l'acheteur les frais d'importation des pièces de réparation ou de remplacement si le produit acheté dans un pays a été expédié dans un autre pays pour y être réparé.

L'obligation de garantie de Fluke est limitée, au choix de Fluke, au remboursement du prix d'achat, ou à la réparation/remplacement gratuit d'un produit défectueux retourné dans le délai de garantie à un centre de service agréé par Fluke.

Pour avoir recours au service de la garantie, mettez-vous en rapport avec le centre de service agréé Fluke le plus proche pour recevoir les références d'autorisation de renvoi, ou envoyez le produit, accompagné d'une description du problème, port et assurance payés (franco lieu de destination), à ce centre de service. Fluke dégage toute responsabilité en cas de dégradations survenues au cours du transport. Après la réparation sous garantie, le produit sera retourné à l'acheteur, frais de port payés d'avance (franco lieu de destination). Si Fluke estime que le problème est le résultat d'une négligence, d'un traitement abusif, d'une contamination, d'une modification, d'un accident ou de conditions de fonctionnement ou de manipulation anormales, notamment de surtensions liées à une utilisation du produit en dehors des spécifications nominales, ou de l'usure normale des composants mécaniques, Fluke fournira un devis des frais de réparation et ne commencera la réparation qu'après en avoir reçu l'autorisation. Après la réparation, le produit sera retourné à l'acheteur, frais de port payés d'avance, et les frais de réparation et de transport lui seront facturés.

LA PRESENTE GARANTIE EST EXCLUSIVE ET TIENT LIEU DE TOUTES AUTRES GARANTIES, EXPLICITES OU IMPLICITES, Y COMPRIS, MAIS NON EXCLUSIVEMENT, TOUTE GARANTIE IMPLICITE QUANT A L'APTITUDE DU PRODUIT A ETRE COMMERCIALISE OU A ETRE APPLIQUE A UNE FIN OU A UN USAGE DETERMINE. FLUKE NE POURRA ETRE TENU RESPONSABLE D'AUCUN DOMMAGE PARTICULIER, INDIRECT, ACCIDENTEL OU CONSECUTIF, NI D'AUCUNS DEGATS OU PERTES, DE DONNEES NOTAMMENT, SUR UNE BASE CONTRACTUELLE, EXTRA-CONTRACTUELLE OU AUTRE.

Etant donné que certains pays ou états n'admettent pas les limitations d'une condition de garantie implicite, ou l'exclusion ou la limitation de dégâts accidentels ou consécutifs, il se peut que les limitations et les exclusions de cette garantie ne s'appliquent pas à chaque acheteur. Si une disposition quelconque de cette garantie est jugée non valide ou inapplicable par un tribunal ou un autre pouvoir décisionnel compétent, une telle décision n'affectera en rien la validité ou le caractère exécutoire de toute autre disposition.

Fluke Corporation  
P.O. Box 9090  
Everett, WA 98206-9090  
Etats-Unis

Fluke Europe B.V.  
P.O. Box 1186  
5602 B.D. Eindhoven  
Pays-Bas

11/99

Pour enregistrer votre produit en ligne, allez à <http://register.fluke.com>.

**Reportez-vous au Mode d'emploi fourni sur le CD d'accompagnement pour les instructions de fonctionnement complètes.**

(French)

## BEGRENZTE GEWÄHRLEISTUNG UND HAFTUNGSBESCHRÄNKUNG

Fluke gewährleistet, daß jedes Fluke-Produkt unter normalem Gebrauch und Service frei von Material- und Fertigungsdefekten ist. Die Garantiedauer beträgt 3 Jahre ab Versanddatum. Die Garantiedauer für Teile, Produktreparaturen und Service beträgt 90 Tage. Diese Garantie wird ausschließlich dem Ersterwerber bzw. dem Endverbraucher geleistet, der das betreffende Produkt von einer von Fluke autorisierten Verkaufsstelle erworben hat, und erstreckt sich nicht auf Sicherungen, Einwegbatterien oder andere Produkte, die nach dem Ermessen von Fluke unsachgemäß verwendet, verändert, verschmutzt, vernachlässigt, durch Unfälle beschädigt oder abnormalen Betriebsbedingungen oder einer unsachgemäßen Handhabung ausgesetzt wurden. Fluke garantiert für einen Zeitraum von 90 Tagen, daß die Software im wesentlichen in Übereinstimmung mit den einschlägigen Funktionsbeschreibungen funktioniert und daß diese Software auf fehlerfreien Datenträgern gespeichert wurde. Fluke übernimmt jedoch keine Garantie dafür, daß die Software fehlerfrei ist und störungsfrei arbeitet.

Von Fluke autorisierte Verkaufsstellen werden diese Garantie ausschließlich für neue und nicht benutzte, an Endverbraucher verkaufte Produkte leisten. Die Verkaufsstellen sind jedoch nicht dazu berechtigt, diese Garantie im Namen von Fluke zu verlängern, auszudehnen oder in irgendeiner anderen Weise abzuändern. Der Erwerber hat nur dann das Recht, aus der Garantie abgeleitete Unterstützungsleistungen in Anspruch zu nehmen, wenn er das Produkt bei einer von Fluke autorisierten Vertriebsstelle gekauft oder den jeweils geltenden internationalen Preis gezahlt hat. Fluke behält sich das Recht vor, dem Erwerber Einfuhrgebühren für Ersatzteile in Rechnung zu stellen, wenn dieser das Produkt in einem anderen Land zur Reparatur anbietet, als dem Land, in dem er das Produkt ursprünglich erworben hat.

Flukes Garantieverpflichtung beschränkt sich darauf, daß Fluke nach eigenem Ermessen den Kaufpreis ersetzt oder aber das defekte Produkt unentgeltlich repariert oder austauscht, wenn dieses Produkt innerhalb der Garantiefrist einem von Fluke autorisierten Servicezentrum zur Reparatur übergeben wird.

Um die Garantieleistung in Anspruch zu nehmen, wenden Sie sich bitte an das nächstgelegene und von Fluke autorisierte Servicezentrum, um Rücknahmeinformationen zu erhalten, und senden Sie dann das Produkt mit einer Beschreibung des Problems und unter Vorauszahlung von Fracht- und Versicherungskosten (FOB Bestimmungsort) an das nächstgelegene und von Fluke autorisierte Servicezentrum. Fluke übernimmt keine Haftung für Transportschäden. Im Anschluß an die Reparatur wird das Produkt unter Vorauszahlung von Frachtkosten (FOB Bestimmungsort) an den Erwerber zurückgesandt. Wenn Fluke jedoch feststellt, daß der Defekt auf Vernachlässigung, unsachgemäße Handhabung, Verschmutzung, Veränderungen am Gerät, einen Unfall oder auf anormale Betriebsbedingungen, einschließlich durch außerhalb der für das Produkt spezifizierten Belastbarkeit verursachten Überspannungsfehlern, zurückzuführen ist, wird Fluke dem Erwerber einen Voranschlag der Reparaturkosten zukommen lassen und erst die Zustimmung des Erwerbers einholen, bevor die Arbeiten begonnen werden. Nach der Reparatur wird das Produkt unter Vorauszahlung der Frachtkosten an den Erwerber zurückgeschickt, und es werden dem Erwerber die Reparaturkosten und die Versandkosten (FOB Versandort) in Rechnung gestellt.

**DIE VORSTEHENDEN GARANTIEBESTIMMUNGEN STELLEN DEN EINZIGEN UND ALLEINIGEN RECHTSANSPRUCH AUF SCHADENERSATZ DES ERWERBERS DAR UND GELTEN AUSSCHLIESSLICH UND AN STELLE VON ALLEN ANDEREN VERTRAGLICHEN ODER GESETZLICHEN GEWÄHRLEISTUNGSPFLICHTEN, EINSCHLIESSLICH - JEDOCH NICHT DARAUf BESCHRÄNKt - DER GESETZLICHEN GEWÄHRLEISTUNG DER MARKTFÄHIGKEIT, DER GEBRAUCHSEIGNUNG UND DER ZWECKDIENLICHKEIT FÜR EINEN BESTIMMTEN EINSATZ. FLUKE HAFTET NICHT FÜR SPEZIELLE, UNMITTELBARE, MITTELBARE, BEGLEIT- ODER FOLGESCHÄDEN ODER VERLUSTE, EINSCHLIESSLICH VERLUST VON DATEN, UNABHÄNGIG VON DER URSACHE ODER THEORIE.**

Angesichts der Tatsache, daß in einigen Ländern die Begrenzung einer gesetzlichen Gewährleistung sowie der Ausschuß oder die Begrenzung von Begleit- oder Folgeschäden nicht zulässig ist, kann es sein, daß die obengenannten Einschränkungen und Ausschlüsse nicht für jeden Erwerber gelten. Sollte eine Klausel dieser Garantiebestimmungen von einem zuständigen Gericht oder einer anderen Entscheidungsinstanz für unwirksam oder nicht durchsetzbar befunden werden, so bleiben die Wirksamkeit oder Durchsetzbarkeit irgendeiner anderen Klausel dieser Garantiebestimmungen von einem solchen Spruch unberührt.

Fluke Corporation  
P.O. Box 9090  
Everett, WA 98206-9090  
USA

Fluke Europe B.V.  
P.O. Box 1186  
5602 BD Eindhoven  
Niederlande

11/99

Zur Registrierung der Software <http://register.fluke.com> besuchen.

**Für vollständige Bedienungsanweisungen siehe das Bedienungshandbuch auf zugehörigen CD.**

(German)

## **GARANZIA LIMITATA & LIMITAZIONE DI RESPONSABILITÀ**

Ogni prodotto Fluke è garantito come esente da difetti nei materiali e nella manodopera per normali situazioni di uso. Il periodo di garanzia è di tre anni a partire dalla data di spedizione. La garanzia per le parti sostituite, le riparazioni e l'assistenza è di 90 giorni. La garanzia è emessa solo a beneficio dell'acquirente originale o del consumatore finale che abbia acquistato il prodotto da un rivenditore Fluke autorizzato. Non copre fusibili, pile di ricambio e qualsiasi apparecchio che, a giudizio della Fluke, sia stato adoperato in modo improprio, modificato, trascurato o danneggiato sia accidentalmente che a causa di condizioni anomale d'uso e manipolazione. La Fluke garantisce per 90 giorni che il software funzionerà sostanzialmente secondo le proprie specifiche operative e che sia stato registrato su supporti non difettosi. Non garantisce che il software sarà esente da errori o che funzionerà senza interruzioni.

I rivenditori autorizzati Fluke sono tenuti ad estendere la presente garanzia per prodotti nuovi e non ancora usati a beneficio esclusivo degli utenti finali, ma non sono autorizzati a emettere una garanzia diversa o più ampia a nome della Fluke. La garanzia è valida solo se il prodotto è stato acquistato attraverso la rete commerciale Fluke o se l'acquirente ha pagato il prezzo non scontato. La Fluke si riserva il diritto di fatturare all'acquirente i costi di importazione dei ricambi per la riparazione/sostituzione eseguita, nel caso in cui il prodotto acquistato in un Paese sia sottoposto a riparazione in un altro.

L'obbligo di garanzia è limitato, a discrezione della Fluke, al rimborso del prezzo d'acquisto, alla riparazione gratuita o alla sostituzione di un prodotto difettoso che sia inviato ad un centro assistenza autorizzato Fluke entro il periodo di garanzia.

Per usufruire dell'assistenza in garanzia, rivolgersi al più vicino centro assistenza autorizzato Fluke per ottenere informazioni sull'autorizzazione al reso. Quindi spedire il prodotto al centro di assistenza. Il prodotto deve essere accompagnato da una descrizione dei problemi riscontrati, e deve essere spedito in porto franco e con assicurazione pre-pagata. La Fluke declina ogni responsabilità per danni in transito. A seguito delle riparazioni in garanzia, il prodotto sarà restituito all'acquirente in porto franco. Se la Fluke accerta che il guasto sia stato causato da negligenza, uso improprio, contaminazione, alterazione, incidente o condizioni anomale di uso e manipolazione (comprese le sovratensioni causate dall'uso dello strumento oltre la propria portata nominale e l'usura dei componenti meccanici dovuta all'uso normale dello strumento), la Fluke presenterà una stima dei costi di riparazione e attenderà l'autorizzazione dell'utente a procedere alla riparazione. In seguito alla riparazione, il prodotto sarà restituito all'acquirente con addebito delle spese di riparazione e di spedizione.

**LA PRESENTE GARANZIA È L'UNICO ED ESCLUSIVO RICORSO DISPONIBILE ALL'ACQUIRENTE ED È EMESSA IN SOSTITUZIONE DI OGNI ALTRA GARANZIA, ESPRESSA OD IMPLICITA, COMPRESA, MA NON LIMITATA AD ESSA, QUALSIASI GARANZIA IMPLICITA DI COMMERCIALIZZABILITÀ O DI IDONEITÀ PER USI PARTICOLARI. LA FLUKE DECLINA OGNI RESPONSABILITÀ PER DANNI O PERDITE PARTICOLARI, INDIRETTI, INCIDENTALI O CONSEGUENTI, COMPRESA LA PERDITA DI DATI DOVUTI A QUALSIASI CAUSA O TEORIA.**

Poiché alcuni Paesi non consentono di limitare i termini di una garanzia implicita né l'esclusione o la limitazione di danni accidentali o sequenziali, le limitazioni e le esclusioni della presente garanzia possono non valere per tutti gli acquirenti. Se una clausola qualsiasi della presente garanzia non è ritenuta valida o attuabile dal tribunale o altro foro competente, tale giudizio non avrà effetto sulla validità delle altre clausole.

Fluke Corporation  
P.O. Box 9090  
Everett, WA 98206-9090  
USA

Fluke Europe B.V.  
P.O. Box 1186  
5602 B.D. Eindhoven  
Olanda

11/99

Per registrare il prodotto in linea, visitare il sito <http://register.fluke.com>.

**Per istruzioni complete sull'uso degli strumenti, fare riferimento al Manuale d'uso contenuto nel CD allegato.**

(Italian)

## **GARANTÍA LIMITADA Y LIMITACIÓN DE RESPONSABILIDAD**

Se garantiza que todo producto de Fluke no tendrá defectos en los materiales ni en la mano de obra en condiciones normales de utilización y mantenimiento. El periodo de garantía es de tres años y comienza en la fecha de despacho. Las piezas de repuesto, reparaciones y servicios son garantizados por 90 días. Esta garantía se extiende sólo al comprador original o al cliente final de un revendedor autorizado por Fluke y no es válida para fusibles, baterías desechables o productos que, en opinión de Fluke, hayan sido utilizados incorrectamente, modificados, maltratados, contaminados o dañados ya sea accidentalmente o a causa de condiciones de funcionamiento o manejo anormales. Fluke garantiza que el software funcionará substancialmente de acuerdo con sus especificaciones funcionales durante 90 días y que ha sido grabado correctamente en un medio magnético sin defectos. Fluke no garantiza que el software no tendrá errores ni que operará sin interrupción.

Los revendedores autorizados por Fluke podrán extender esta garantía solamente a los Compradores finales de productos nuevos y sin uso previo, pero carecen de autoridad para extender una garantía mayor o diferente en nombre de Fluke. La asistencia técnica en garantía estará disponible únicamente si el producto fue comprado a través de un centro de distribución autorizado por Fluke o si el comprador pagó el precio internacional correspondiente. Fluke se reserva el derecho a facturar al Comprador los costos de importación de reparaciones/repuestos cuando el producto comprado en un país es enviado a reparación a otro país.

La obligación de Fluke de acuerdo con la garantía está limitada, a discreción de Fluke, al reembolso del precio de compra, reparación gratuita o al reemplazo de un producto defectuoso que es devuelto a un centro de servicio autorizado por Fluke dentro del periodo de garantía. Para obtener el servicio de la garantía, comuníquese con el centro de servicio autorizado por Fluke más cercano a usted, solicite la información correspondiente a la autorización de la devolución y luego envíe el producto a dicho centro de servicio con una descripción del fallo y los portes y el seguro prepagados (FOB destino). Fluke no asume ningún riesgo por daño durante el tránsito. Después de la reparación de garantía, el producto será devuelto al Comprador, con los fletes prepagados (FOB destino). Si Fluke determina que el fallo fue causado por maltrato, mala utilización, contaminación, modificación o por una condición accidental o anormal presentada durante el funcionamiento o manejo, incluidos los fallos por sobretensión causados por el uso fuera de los valores nominales especificados para el producto, o por el desgaste normal de los componentes mecánicos, Fluke preparará una estimación de los costos de reparación y obtendrá su autorización antes de comenzar el trabajo. Al concluir la reparación, el producto será devuelto al Comprador con los fletes prepagados y al Comprador le serán facturados la reparación y los costos de transporte (FOB en el sitio de despacho).

**ESTA GARANTÍA ES EL ÚNICO Y EXCLUSIVO RECURSO DEL COMPRADOR Y SUBSTITUYE A TODAS LAS OTRAS GARANTÍAS, EXPRESAS O IMPLÍCITAS, INCLUYENDO, PERO SIN LIMITARSE A, TODA GARANTÍA IMPLÍCITA DE COMERCIABILIDAD O IDONEIDAD PARA UN PROPÓSITO DETERMINADO. FLUKE NO SE RESPONSABILIZA DE PÉRDIDAS NI DAÑOS ESPECIALES, INDIRECTOS, IMPREVISTOS O CONTINGENTES, INCLUIDA LA PÉRDIDA DE DATOS, QUE SURJAN POR CUALQUIER TIPO DE CAUSA O TEORÍA.**

Como algunos países o estados no permiten la limitación de los términos de una garantía implícita, ni la exclusión ni limitación de daños incidentales o consecuentes, las limitaciones y exclusiones de esta garantía pueden no ser válidas para todos los Compradores. Si una cláusula de esta Garantía es considerada inválida o inaplicable por un tribunal o por algún otro ente de jurisdicción competente y responsable de la toma de decisiones, dicha consideración no afectará la validez o aplicabilidad de cualquier otra cláusula.

Fluke Corporation  
P.O. Box 9090,  
Everett, WA 98206-9090  
EE.UU.

Fluke Europe B.V.  
P.O. Box 1186,  
5602 BD Eindhoven  
Países Bajos

11/99

Para registrar su producto en línea, visite <http://register.fluke.com>.

**Para obtener instrucciones operacionales completas, consulte el Manual de uso de contenido en el CD adjunto.**

(Spanish)

## GARANTIA LIMITADA E LIMITAÇÃO DE RESPONSABILIDADE

Todos os produtos da Fluke são garantidos contra defeitos de material ou fabricação, sob circunstâncias normais de uso e manutenção. O período de garantia é de três anos, a partir da data da remessa. As peças, reparos e serviços são garantidos por 90 dias. Esta garantia se aplica apenas ao comprador original, ou ao cliente usuário-final de um revendedor autorizado da Fluke, e não cobre fusíveis, baterias descartáveis, nem qualquer produto que, na opinião da Fluke, tenha sido usado de forma inadequada, alterado, tenha recebido manutenção inadequada ou tenha sido danificado por acidente ou condições anormais de operação ou manuseio. A Fluke garante que o software funcionará de acordo com as suas especificações técnicas pelo período de 90 dias, e que foi gravado de forma adequada em meio físico sem defeitos. A Fluke não garante que o software esteja livre de defeitos, nem que funcionará sem interrupções.

Os vendedores autorizados da Fluke fornecerão esta garantia de produtos novos e não usados apenas a clientes usuários finais, mas não têm qualquer autoridade para fornecer, em nome da Fluke, uma garantia mais ampla ou diferente da presente. A assistência técnica coberta pela garantia está disponível se o produto houver sido adquirido de uma loja autorizada da Fluke, ou se o Comprador tiver pago o preço internacional aplicável. A Fluke se reserva o direito de cobrar do Comprador taxas relativa a custos de importação referentes a peças de substituição/reparos quando o produto for comprado em um país e submetido para reparos em um outro país.

As obrigações da Fluke pertinentes a esta garantia são limitadas, a critério da Fluke, à devolução da importância correspondente ao preço pago pela compra do produto, reparos gratuitos, ou substituição de um produto defeituoso que seja devolvido a um centro autorizado de reparos da Fluke dentro do período coberto pela garantia.

Para obter serviços cobertos pela garantia, entre em contato com o centro autorizado de reparos da Fluke mais próximo para obter informações sobre autorizações de retorno e então, envie o produto para o centro autorizado, com uma descrição do problema encontrado e com frete e seguro já pagos (FOB no destino), ao centro autorizado de reparos mais próximo. A Fluke não se responsabiliza por nenhum dano que possa ocorrer durante o transporte. Após serem efetuados os serviços cobertos pela garantia, o produto será devolvido ao Comprador, com frete já pago (FOB no destino). Se a Fluke constatar que a falha do produto foi causada por uso inadequado, contaminação, alterações, acidente, ou condições anormais de operação ou manuseio, inclusive falhas devidas a sobretensão causadas pelo uso do produto fora das faixas e classificações especificadas, ou pelo desgaste normal de componentes mecânicos, a Fluke dará uma estimativa dos custos de reparo, e obterá autorização do cliente antes de começar os reparos. Após a realização dos reparos, o produto será devolvido ao Comprador com frete já pago e este reembolsará a Fluke pelos custos dos reparos e do transporte de retorno (FOB no local de remessa).

ESTA GARANTIA É O ÚNICO E EXCLUSIVO RECURSO JURÍDICO DO COMPRADOR, E SUBSTITUI TODAS AS OUTRAS GARANTIAS, EXPRESSAS OU IMPLÍCITAS, INCLUINDO, MAS NÃO SE LIMITANDO A, QUALQUER GARANTIA IMPLÍCITA DE COMERCIALIZAÇÃO OU ADEQUABILIDADE PARA UM DETERMINADO FIM. A FLUKE NÃO SE RESPONSABILIZA POR NENHUM DANO OU PERDA, INCIDENTAL OU CONSEQUENTE, QUE POSSA OCORRER POR QUALQUER MOTIVO OU QUE SEJA DECORRENTE DE QUALQUER CAUSA OR TEORIA JURÍDICA.

Como alguns estados ou países não permitem a exclusão ou limitação de uma garantia implícita nem de danos incidentais ou consequentes, esta limitação de responsabilidade pode não ser aplicável no seu caso. Se uma corte qualificada de jurisdição considerar qualquer provisão desta garantia inválida ou não-executável, tal decisão judicial não afetará a validade ou executabilidade de qualquer outra provisão.

Fluke Corporation  
P.O. Box 9090  
Everett, WA 98206-9090  
E.U.A.

Fluke Europe B.V.  
P.O. Box 1186  
5602 BD Eindhoven  
Holanda

11/99

Para registrar produtos on-line, visite o site <http://register.fluke.com>.

**Para obter instruções completas de operação, veja o Manual do Usuário do contido no CD fornecido com o instrumento.**

(Portuguese)

## BEGRÄNSAD GARANTI OCH ANSVARSBEGRÄNSNING

Varje Flukeprodukt garanteras vara fri från felaktigheter i material och utförande vid normal användning och service. Garantiperioden är tre år och räknas från leveransdagen. För delar, produktreparationer och service gäller 90 dagars garanti. Denna garanti gäller endast för den ursprungliga köparen eller slutkunden, som handlat hos en auktoriserad Flukeåterförsäljare, och omfattar inte säkringar, engångsbatterier eller produkter, som enligt Flukes förmenande har använts på felaktigt sätt, ändrats, smutsats ner eller skadats till följd av olyckshändelse eller onormala användningsförhållanden eller onormal hantering. Fluke garanterar att programvaran fungerar i allt väsentligt i enlighet med dess funktionella specifikationer i 90 dagars tid, och att den lagrats på korrekt sätt på icke-defekta datamedia. Fluke garanterar inte att programvaran är felfri och heller inte att den fungerar utan avbrott.

Flukes auktoriserade återförsäljare förmedlar denna garanti endast till slutanvändarkunder för nya och obegagnade produkter, men har ingen behörighet att erbjuda en mer omfattande eller annorlunda garanti i Flukes namn. Garantisupport finns endast tillgänglig om produkten köpts i av Fluke auktoriserad butik, eller om köparen erlagt det tillämpliga internationella priset. Fluke förbehåller sig rätten att debitera köparen för importkostnaden för reparations/ersättningsdelar, om en produkt som inköpts i ett land lämnas in för reparation i ett annat land.

Flukes garantiåtagande begränsar sig till, efter Flukes bedömning, antingen återbetalning av inköpspriset, kostnadsfri reparation eller utbyte av en felaktig produkt, som lämnas in/återsänds till av Fluke auktoriserad serviceverkstad under garantitiden.

För att få garantiservice kontaktar du närmaste av Fluke auktoriserade serviceverkstad för returtilstånd, och skickar sedan produkten till serviceverkstaden ifråga med en beskrivning av de problem som föreligger, med sändnings- och servicekostnaderna förbetalda (FOB destinationen). Fluke tar inte på sig något ansvar för skador som kan uppkomma vid försändningen. Efter garantireparationen återsänds produkten till köparen, med sändningskostnaderna förbetalda (FOB destinationen). Om Fluke bedömer att felet har förorsakats av försummelse, felaktig användning, nedsmutsning, ändring, olyckshändelse eller onormala förhållanden eller onormal hantering, inberäknat överspänningsfel till följd av användning utanför de värden som specificerats för produkten, eller normal förslitning av mekaniska komponenter, kommer Fluke and lämna besked om de uppskattade reparationskostnaderna och invänta godkännande av dessa innan arbetet påbörjas. Efter reparationen återsänds produkten till köparen med sändningskostnaden förbetald varefter köparen faktureras för reparationskostnaden och återsändningskostnaden (FOB leveransstället).

DENNA GARANTI ÄR KÖPARENS ENDA GOTTGÖRELSE OCH ERSÄTTER ALLA ANDRA GARANTIER, UTTRYCKLIGA ELLER UNDERFÖRSTÅDDA, INKLUSIVE MEN INTE BEGRÄNSAT TILL GARANTIER AVSEENDE SÄLJBARHET ELLER LÄMPLIGHET FÖR EN VISS ANVÄNDNING. FLUKE KAN INTE GÖRAS ANSVARIGT FÖR NÅGRA SPECIELLA SKADOR, INDIREKTA SKADOR, OFÖRUTSEDDA SKADOR ELLER FÖLJDSKADOR, INKLUSIVE FÖRLORADE DATA, OAVSETT ANLEDNING ELLER TEORETISK ORSAK.

Vissa stater eller länder tillåter inte begränsningar av en underförstådd garantis löptid, eller undantag eller begränsning av tillfälliga skador eller följskador, varför begränsningarna och undantagen i denna garanti kanske inte gäller för varje köpare. Om något villkor i denna garanti skulle konstateras vara ogiltigt eller otillämpligt av en behörig domstol eller motsvarande, skall ett sådant utslag inte inverka på giltigheten eller tillämpbarheten hos något annat villkor.

Fluke Corporation  
P.O. Box 9090  
Everett, WA 98206-9090  
USA

Fluke Europe B.V.  
P.O. Box 1186  
NL-5602 BD Eindhoven  
Nederländerna

11/99

Registrera din produkt online på [register.fluke.com](http://register.fluke.com).

**Fullständiga användaranvisningar finns i Användarhandbok på den medföljande cd-skivan.**

(Swedish)



## 有限担保和有限责任

Fluke 担保在正常使用和保养的情况下，其产品没有材料和工艺上的缺陷。从寄送之日起，担保期为三年。部件、产品修理和服务的担保期限为 90 天。本担保仅限于 Fluke 授权零售商的原购买人或最终用户，并且不适用于一次性电池、电缆接头、电缆绝缘转换接头或 Fluke 认为由于误用、改装、疏忽、污染及意外或异常操作或处理引起的任何产品损坏。Fluke 担保软件能依照功能规格正常运行 90 天，并且软件是记录在无缺陷的媒介上。Fluke 并不担保软件毫无错误或在运行中不会中断。

Fluke 授权的零售商应仅对最终用户就新的和未使用的产品提供本担保，但无权代表 Fluke 公司提供额外或不同的担保。只有通过 Fluke 授权的销售店购买的产品或者买方已经按适用的国际价格付款才能享受 Fluke 的担保支持。在一国购买的产品需在他国修理时，Fluke 有权向买方要求负担重大修理/零件更换费用。

Fluke 的担保为有限责任，由 Fluke 决定是否退还购买金额、免费修理或更换在担保期间退还 Fluke 授权服务中心的故障产品。

如需要保修服务，请与您就近的 Fluke 授权服务中心联系，获得退还授权信息；然后将产品寄至服务中心，并附上产品问题描述，同时预付运费和保险费（目的地离岸价格）。Fluke 不承担运送途中发生的损坏。在保修之后，产品将被寄回给买方并提前支付运输费（目的地交货）。如果 Fluke 认定产品故障是由于疏忽、误用、污染、修改、意外或不当操作或处理状况而产生，包括未在产品规定的额定值下使用引起的过压故障；或是由于机件日常使用损耗，则 Fluke 会估算修理费用，在获得买方同意后再进行修理。在修理之后，产品将被寄回给买方并预付运输费；买方将收到修理和返程运输费用（寄发地交货）的帐单。

本担保为买方唯一能获得的全部补偿内容，并且取代所有其它明示或隐含的担保，包括但不限于适销性或满足特殊目的任何隐含担保。FLUKE 对任何特殊、间接、偶发或后续的损坏或损失概不负责，包括由于任何原因或推理引起的数据丢失。

由于某些国家或州不允许对隐含担保的期限加以限制、或者排除和限制意外或后续损坏，本担保的限制和排除责任条款可能并不对每一个买方都适用。如果本担保的某些条款被法院或其它具有适当管辖权的裁决机构判定为无效或不可执行，则此类判决将不影响任何其它条款的有效性或可执行性。

Fluke Corporation  
P.O. Box 9090  
Everett, WA 98206-9090  
U.S.A.

Fluke Europe B.V.  
P.O. Box 1186  
5602 BD Eindhoven  
The Netherlands

11/99

如要在线注册您的产品，请访问 [register.fluke.com](http://register.fluke.com).

**若需要完整的操作说明，请参阅随附光盘中包含的用户手册。**

(Simplified Chinese)

## ОГРАНИЧЕННАЯ ГАРАНТИЯ И ОГРАНИЧЕНИЕ ОТВЕТСТВЕННОСТИ

Для каждого продукта Fluke гарантируется отсутствие дефектов материалов и изготовления при нормальном использовании и обслуживании. Гарантийный срок составляет три года и отсчитывается от даты поставки. На запчасти, ремонт оборудования и услуги предоставляется гарантия 90 дней. Эта гарантия действует только для первоначального покупателя или конечного пользователя, являющегося клиентом авторизованного реселлера Fluke, и не распространяется на предохранители, одноразовые батареи и на любые продукты, которые, по мнению Fluke, неправильно или небрежно использовались, были изменены, загрязнены или повреждены вследствие несчастного случая или ненормальных условий работы или обработки. Fluke гарантирует, что программное обеспечение будет работать в соответствии с его функциональными характеристиками в течение 90 дней, и что оно правильно записано на исправных носителях. Fluke не гарантирует, что программное обеспечение будет работать безошибочно и без остановок.

Авторизованные реселлеры Fluke расширят действие этой гарантии на новые и неиспользованные продукты только для конечных пользователей, но они не уполномочены расширять условия гарантии или вводить новые гарантийные обязательства от имени Fluke. Гарантийная поддержка предоставляется, только если продукт приобретен на авторизованной торговой точке Fluke, или покупатель заплатил соответствующую международную цену. Fluke оставляет за собой право выставить покупателю счет за расходы на ввоз запасных/сменных частей, когда продукт, приобретенный в одной стране, передается в ремонт в другой стране. Гарантийные обязательства Fluke ограничены по усмотрению Fluke выплатой покупной цены, бесплатным ремонтом или заменой неисправного продукта, который возвращается в авторизованный сервисный центр Fluke в течение гарантийного периода.

Для получения гарантийного сервисного обслуживания обратитесь в ближайший авторизованный сервисный центр Fluke за информацией о праве на возврат, затем отправьте продукт в этот сервисный центр с описанием проблемы, оплатив почтовые расходы и страховку (ФОБ пункт назначения). Fluke не несет ответственности за повреждение при перевозке. После осуществления гарантийного ремонта продукт будет возвращен покупателю с оплаченной перевозкой (ФОБ пункт назначения). Если Fluke определяет, что неисправность вызвана небрежностью, неправильным использованием, загрязнением, изменением, несчастным случаем или ненормальными условиями работы и обработки, включая электрическое перенапряжение из-за несоблюдения указанных допустимых значений, или обычным износом механических компонентов, Fluke определит стоимость ремонта и начнет работу после получения разрешения. После ремонта продукт будет возвращен покупателю с оплаченной перевозкой, и покупателю будет выставлен счет за ремонт и транспортные расходы при возврате (ФОБ пункт отгрузки). ЭТА ГАРАНТИЯ ЯВЛЯЕТСЯ ЕДИНСТВЕННОЙ И ИСКЛЮЧИТЕЛЬНОЙ И ЗАМЕНЯЕТ ВСЕ ОСТАЛЬНЫЕ ГАРАНТИИ, ПРЯМЫЕ ИЛИ СВЯЗАННЫЕ, ВКЛЮЧАЯ, ПОМИМО ПРОЧЕГО, СВЯЗАННЫЕ ГАРАНТИИ ГОДНОСТИ ДЛЯ ПРОДАЖИ ИЛИ ГОДНОСТИ ДЛЯ ОПРЕДЕЛЕННОЙ ЦЕЛИ. FLUKE НЕ НЕСЕТ ОТВЕТСТВЕННОСТИ ЗА СПЕЦИАЛЬНЫЕ, СЛУЧАЙНЫЕ ИЛИ КОСВЕННЫЕ ПОВРЕЖДЕНИЯ ИЛИ УЩЕРБ, ВКЛЮЧАЯ ПОТЕРЮ ДАННЫХ, ЯВЛЯЮЩИЕСЯ РЕЗУЛЬТАТОМ КАКИХ-ЛИБО ДЕЙСТВИЙ ИЛИ МЕТОДОВ.

Поскольку некоторые страны не допускают ограничения срока связанной гарантии или исключения и ограничения случайных или косвенных повреждений, ограничения этой гарантии могут относиться не ко всем покупателям. Если какое-либо положение этой гарантии признано судом или другим директивным органом надлежащей юрисдикции недействительным или не имеющим законной силы, такое признание не повлияет на действительность или законную силу других положений.

Fluke Corporation  
P.O. Box 9090  
Everett, WA 98206-9090  
U.S.A.

Fluke Europe B.V.  
P.O. Box 1186  
5602 BD Eindhoven  
The Netherlands

11/99

Для регистрации продукта зайдите на сайт <http://register.fluke.com>.

**Полная информация об использовании измерителя содержится в "Руководстве пользователя мультиметров моделей", которое находится на прилагаемом компакт-диске.**

(Russian)

## SINIRLI GARANTİ VE SORUMLULUK SINIRI

Tüm Fluke ürünleri, normal kullanım ve servis koşulları altında madde ve işçilik kusurları olmayacağı konusunda garanti altına alınmıştır. Garanti süresi iki yıl olup, ürünün gönderildiği tarihte başlar. Parçalar, ürün onarımları ve servisler, 90 gün için garanti altına alınmıştır. Bu garanti ancak asıl satın alan veya Fluke yetkili bayinin son kullanıcı müşterisi için geçerli olup, sigortalar, tek kullanımlık piller veya Fluke şirketine göre yanlış kullanıldığı, değiştirildiği, ihmal edildiği, orijinalliği bozulduğu ya da yanlışlıkla veya anormal bir kullanım ya da işleme sonucu hasara uğradığı düşünülen hiçbir ürün için geçerli değildir. Fluke, yazılımın teknik çalışma özelliklerine önemli derecede uygun çalışacağını ve kusursuz bilgi saklama ortamı üzerine gerektiği gibi kaydedilmiş olduğunu 90 günlük bir süre için garanti eder. Fluke, yazılımın kesintisiz bir şekilde çalışacağını ya da hatasız olacağını garanti etmez. Fluke yetkili bayileri, bu garantiyi yeni ve kullanılmamış ürünler için, son kullanıcı müşterilerine verebilir, ancak Fluke adına daha kapsamlı ya da farklı bir garanti veremez. Garanti desteği ancak ürün Fluke yetkili satış noktası aracılığıyla satın alındıysa ya da Alıcı geçerli uluslararası fiyatı ödemişse sağlanır. Fluke, ürünün bir ülkede satın alınıp onarım için başka bir ülkeye gönderilmesi durumunda, parça onarım / değiştirme ithal ücretini faturalama hakkını saklı tutar. Fluke şirketinin garanti yükümlülüğü, şirketin seçiminde, garanti süresi içinde Fluke yetkili servis merkezine geri verilen kusurlu ürünün satın alım fiyatını iade etmesi, ücretsiz onarımı veya değiştirilmesi ile sınırlıdır.

Garanti hizmetini almak için en yakın Fluke yetkili servis merkezine giderek iade onay bilgilerini alınız, sonra da ürünü sorunun tarifıyla birlikte, posta ve sigorta ücreti önceden ödenmiş olarak (FOB Varış Noktasında) o servis merkezine gönderiniz. Fluke, ulaşım sırasındaki hasarlardan sorumlu tutulamaz. Garanti onarımından sonra ürün, ulaşım ücreti önceden ödenmiş olarak (FOB Varış Noktası) Alıcıya geri gönderilecektir. Fluke, bozukluğun ihmali, yanlış kullanımı, ürünün orijinalliğinin bozulması, değiştirme, kaza veya ürünün belirlenen elektrik derecelendirmesi dışında kullanılması sonucu aşırı voltaj da dahil, anormal kullanım veya işleme koşulları ya da mekanik bileşenlerin normal aşınması ve eskimesi nedeniyle olduğunu saptarsa, onarım masrafları için bir tahminde bulunacak ve işe başlamadan önce onay alacaktır. Onarımdan sonra ürün, ulaşım ücreti önceden ödenmiş olarak Alıcıya geri gönderilecek ve Alıcı, onarım ve geri gönderim ücretleri (FOB Nakliyat Noktası) için faturalanacaktır.

**BU GARANTİ, ALICININ TEK VE YALNIZ KENDİSİNE TANINAN ÇÖZÜM HAKKI OLUP, PAZARLANABİLİRLİK VE BELLİ BİR AMACA UYGUNLUK GİBİ İMA EDİLEN GARANTİLER DE DAHİL, ANCAK BUNLARLA SINIRLI OLMAKSIZIN AÇIK VEYA İMA EDİLEN DİĞER TÜM GARANTİLERİN YERİNE GEÇER. FLUKE, HERHANGİ BİR NEDEN VEYA TEORİ SONUCU OLUŞAN ÖZEL, DOLAYLI, ARIZİ VEYA TESADÜFİ VERİ KAYBI DA DAHİL, HİÇBİR KAYIP VE ZARARDAN SORUMLU TUTULAMAZ.**

Bazı ülke ve eyaletler, ima edilen bir garanti maddesinin sınırlandırılmasına ya da tesadüfi veya sonuçsal zararların sınırlandırılması veya kapsam dışı bırakılmasına izin vermediğinden, bu garantinin sınırlandırılması veya kapsam dışında bırakılması, her alıcı için geçerli olmayabilir. Bu Garantinin herhangi bir maddesi bir mahkeme veya yargı konusunda yetkili başka bir karar organı tarafından geçersiz veya yürürlüğe konamaz olarak kabul edildiğinde, bu uygulama, diğer hükümlerin geçerlik ve uygulanabilirliğini etkilemeyecektir.

Fluke Corporation  
P.O. Box 9090  
Everett, WA 98206-9090  
A.B.D.

Fluke Europe B.V.  
P.O. Box 1186  
5602 BD Eindhoven  
Hollanda

11/99

Ürününüzü İnternet'te kaydetmek için <http://register.fluke.com> adresine gidiniz.

**Eksiksiz çalıştırma talimatları için, ektteki CD'de yer alan Kullanım Kılavuzuna başvurun.**

(Turkish)

## OGRANICZONA GWARANCJA I OGRANICZENIE ODPOWIEDZIALNOŚCI

Każdy produkt firmy Fluke posiada gwarancję na brak usterek materiałowych i produkcyjnych w warunkach normalnego użytkowania i konserwacji. Okres gwarancji obejmuje trzy lata i rozpoczyna się w dniu wysłania produktu. Części, naprawy produktu oraz serwisowanie są objęte gwarancją przez 90 dni. Niniejsza gwarancja obejmuje jedynie oryginalnego nabywcę lub użytkownika końcowego będącego klientem autoryzowanego sprzedawcy firmy Fluke i nie obejmuje bezpieczników, jednorazowych baterii lub żadnych innych produktów, które, w opinii firmy Fluke, były używane niezgodnie z ich przeznaczeniem, modyfikowane, zaniedbane, zanieczyszczone lub uszkodzone przez przypadek lub w wyniku nienormalnych warunków użytkowania lub obsługi. Firma Fluke gwarantuje zasadnicze działanie oprogramowania zgodnie z jego specyfikacjami funkcjonalności przez 90 dni oraz, że zostało ono prawidłowo nagrane na wolnym od usterek nośniku. Firma Fluke nie gwarantuje, że oprogramowanie będzie wolne od błędów lub że będzie działać bez przerwy.

Autoryzowani sprzedawcy firmy Fluke przedłużą niniejszą gwarancję na nowe i nieużywane produkty jedynie dla swoich klientów będących użytkownikami końcowymi, jednak nie będą posiadać uprawnień do przedłużenia obszerniejszej lub innej gwarancji w imieniu firmy Fluke. Wsparcie gwarancyjne jest dostępne jedynie w przypadku, gdy produkt został zakupiony w autoryzowanym punkcie sprzedaży firmy Fluke lub Nabywca zapłacił odpowiednią cenę międzynarodową. Firma Fluke rezerwuje sobie prawo do zafakturowania na Nabywcę kosztów importu części do naprawy/wymiany w przypadku, gdy produkt nabyty w jednym kraju zostanie oddany do naprawy w innym kraju.

Zobowiązania gwarancyjne firmy Fluke są ograniczone, według uznania firmy Fluke, do zwrotu kosztów zakupu, darmowej naprawy lub wymiany wadliwego produktu, który zostanie zwrócony do autoryzowanego centrum serwisowego firmy Fluke przed upływem okresu gwarancyjnego.

Aby skorzystać z usługi gwarancyjnej, należy skontaktować się z najbliższym autoryzowanym centrum serwisowym firmy Fluke w celu uzyskania zwrotnej informacji autoryzacyjnej, a następnie przesłać produkt do tego centrum serwisowego wraz z opisem problemu, zwrotną kopertą ze znaczkami oraz opłaconym ubezpieczeniem (miejsce docelowe FOB). Firma Fluke nie jest odpowiedzialna za wszelkie uszkodzenia powstałe w czasie transportu. Po naprawie gwarancyjnej produkt zostanie zwrócony Nabywcy przy wcześniej opłaconym transporcie (miejsce docelowe FOB). Jeśli firma Fluke dojdzie do wniosku, że usterka została spowodowana przez zaniedbanie, niewłaściwe użytkowanie, zanieczyszczenie, modyfikacje lub nienormalne warunki użytkowania lub obsługi, łącznie z przebiegami spowodowanymi użytkowaniem urządzenia w środowisku przekraczającym jego wyszczególnione zakresy pracy lub normalne zużycie części mechanicznych, firma Fluke zapewni szacunkowe wartości kosztów naprawy i uzyska upoważnienie przed rozpoczęciem pracy. Po zakończeniu naprawy, produkt zostanie zwrócony Nabywcy przy wcześniej opłaconym transporcie i Nabywca zostanie obciążony kosztami naprawy i transportu zwrotnego (punkt wysłania FOB). NINIEJSZA GWARANCJA STANOWI JEDYNE I WYŁĄCZNE ZADOSĆCZYNIENIE DLA NABYWCY W MIEJSCIE WSZYSTKICH INNYCH GWARANCJI, WYRĄŻNYCH LUB DOROZUMIANYCH, OBEJMUJĄCYCH, ALE NIE OGRANICZONYCH DO ŻADNEJ DOROZUMIANEJ GWARANCJI ZBYWAŁNOŚCI LUB ZDATNOŚCI DO DANEGO CELU. FIRMA FLUKE NIE BĘDZIE ODPOWIEDZIALNA ZA ŻADNE SPECJALNE, POŚREDNIE, PRZYPADKOWE LUB NASTĘPUJĄCE STRATY, ŁĄCZNIE Z UTRATĄ DANYCH, WYNIKAJĄCE Z JAKIEJKOLWIEK PRZYCZYNY LUB TEORII.

Ponieważ niektóre kraje lub stany nie zezwalają na ograniczenie terminu dorozumianej gwarancji lub wyłączenia, lub ograniczenia przypadkowych, lub następujących strat, ograniczenia i wyłączenia z niniejszej gwarancji mogą nie mieć zastosowania dla każdego nabywcy. Jeśli którykolwiek z przepisów niniejszej Gwarancji zostanie podważony lub niemożliwy do wprowadzenia przez sąd lub inny kompetentny organ decyzyjny odpowiedniej jurysdykcji, nie będzie to mieć wpływu na obowiązywanie wszystkich innych przepisów niniejszej Gwarancji.

Fluke Corporation  
P.O. Box 9090  
Everett, WA 98206-9090  
U.S.A.

Fluke Europe B.V.  
P.O. Box 1186  
5602 BD Eindhoven  
Holandia

11/99

Aby zarejestrować produkt przez Internet, proszę przejść do witryny pod adresem <http://register.fluke.com>.

**Szczegółowe procedury użytkowania zawiera Instrukcja obsługi, znajdująca się na dołączonym dysku CD.**

(Polish)

## OMEZENÁ ZÁRUKA A OMEZENÍ ZODPOVĚDNOSTI

Firma Fluke garantuje, že každý její výrobek je prost vad materiálu a zpracování při normálním použití a servisu. Záruční doba je tři roky a začíná datem expedice. Díly, opravy produktů a servis jsou garantovány 90 dní. Tato záruka se vztahuje pouze na původního kupujícího nebo koncového uživatele jako zákazníka autorizovaného prodejce výrobků firmy Fluke a nevztahuje se na pojistky, jednorázové baterie ani jakýkoliv produkt, který podle názoru firmy Fluke byl použit nesprávným způsobem, pozměněn, zanedbán, znečištěn nebo poškozen v důsledku nehody nebo nestandardních podmínek při provozu či manipulaci. Firma Fluke garantuje, že software bude v podstatě fungovat v souladu s funkčními specifikacemi po dobu 90 dnů a že byl správně nahrán na nepoškozené médium. Společnost Fluke neručí za to, že software bude bezporuchový a že bude fungovat bez přerušení.

Autorizovaní prodejci výrobků firmy Fluke mohou tuto záruku rozšířit na nové a nepoužité produkty pro koncové uživatele, ale nemají oprávnění poskytnout větší nebo odlišnou záruku jménem firmy Fluke. Záruční podpora se poskytuje, pouze pokud je produkt zakoupen v autorizované prodejně firmy Fluke anebo kupující zaplatil příslušnou mezinárodní cenu. Firma Fluke si vyhrazuje právo fakturovat kupujícímu náklady na dovezené díly pro opravu nebo výměnu, pokud je produkt předložen k opravě v jiné zemi, než kde byl zakoupen.

Povinnosti firmy Fluke vyplývající z této záruky jsou omezeny, podle uvážení firmy Fluke, na vrácení nákupní ceny, opravu zdarma nebo výměnu vadného produktu vráceného autorizovanému servisu firmy Fluke v záruční době.

Nárokujete-li záruční opravu, obraťte se na nejbližší autorizované servisní středisko firmy Fluke pro informace o oprávnění k vrácení, potom do servisního střediska zašlete produkt s popisem potíží, s předplaceným poštovním a pojištěním (vyplaceně na palubu v místě určení). Firma Fluke nepřebírá riziko za poškození při dopravě. Po záruční opravě bude produkt vrácen kupujícímu, dopravné předplaceno (vyplaceně na palubu v místě určení). Pokud firma Fluke rozhodne, že porucha byla způsobena zanedbáním, špatným použitím, znečištěním, úpravou, nehodou nebo nestandardními podmínkami při provozu či manipulaci, včetně přepětí v důsledku použití napájecí sítě s jinými vlastnostmi, než je specifikováno, nebo normálním opotřebením mechanických komponent, firma Fluke před zahájením opravy sdělí odhad nákladů na opravu a vyžádá si souhlas. Po opravě bude produkt vrácen kupujícímu, dopravné předplaceno a kupujícímu bude účtována oprava a náklady na zpáteční dopravu (vyplaceně na palubu v místě expedice).

TATO ZÁRUKA JE JEDINÝM A VÝHRADNÍM NÁROKEM KUPUJÍCÍHO A NAHRAZUJE VŠECHNY OSTATNÍ ZÁRUKY, VÝSLOVNÉ NEBO IMPLICITNÍ, VČETNĚ, ALE NIKOLI VÝHRADNĚ, IMPLICITNÍCH ZÁRUK OBCHODOVATELNOSTI NEBO VHODNOSTI PRO URČITÝ ÚČEL. FIRMA FLUKE NEODPOVÍDÁ ZA ŽÁDNÉ ZVLÁŠTNÍ, NEPŘÍMÉ, NÁHODNÉ NEBO NÁSLEDNÉ ŠKODY NEBO ZTRÁTY, VČETNĚ ZTRÁTY DAT, VZNIKLÉ Z JAKÉKOLIV PŘÍČINY NEBO PŘEDPOKLADU. Jelikož některé země nebo státy neumožňují omezení podmínek implicitní záruky ani vyloučení či omezení u náhodných nebo následných škod, omezení a vyloučení této záruky se nemusí vztahovat na všechny kupující. Je-li kterékoli ustanovení této záruky shledáno neplatným nebo nevykonatelným soudem nebo jinou rozhodovací autoritou příslušné jurisdikce, není tím dotčena platnost nebo vynutitelnost jakéhokoliv jiného ustanovení.

Fluke Corporation  
P.O. Box 9090  
Everett, WA 98206-9090  
U.S.A.

Fluke Europe B.V.  
P.O. Box 1186  
5602 BD Eindhoven  
Holandsko

11/99

Pro registraci produktu on-line navštivte stránku <http://register.fluke.com>.

**Podrobné provozní instrukce naleznete v uživatelské příručce dodané na disku CD.**

(Czech)



# Table of Contents

Title	Page
Introduction .....	1
To Contact Fluke .....	2
Safety Information .....	3
Symbols .....	5
Unpack the Tester .....	6
The Tester .....	7
Pushbuttons .....	8
Turn the Tester On and Off .....	9
Display .....	10
Charge the Battery .....	11
Guard Terminal Use .....	12
Measurements .....	14
Connect to the Circuit Under Test .....	14
Before an Insulation Test .....	16
Preset Test Voltage Selection .....	16
Program a Test Voltage .....	17
Select a Ramp or Steady-State Test .....	18
Set a Timed Test .....	18
Polarization Index (PI) .....	19
Dielectric Absorption Ratio .....	19
Capacitance .....	19
Insulation Test .....	20
Store Test Results .....	22
View Results Stored in Memory .....	23
Download Your Test Results .....	24
Install FlukeView Forms Basic Software .....	25
Download Results to PC .....	26
Delete Test Results .....	26
Maintenance .....	27
Cleaning .....	27
Replaceable Parts and Accessories .....	28
Specifications .....	29
General Specifications .....	29

Electrical Specifications .....	30
Principle of Measurement and Resistance .....	32



# ***List of Tables***

<b>Table</b>	<b>Title</b>	<b>Page</b>
1.	Symbols .....	5
2.	List of Replacable Parts.....	28
3.	Accessories .....	29

# ***List of Figures***

<b>Figure</b>	<b>Title</b>	<b>Page</b>
1.	Standard Items Provided .....	6
2.	1550C/1555 Insulation Tester .....	7
3.	Pushbuttons.....	8
4.	Display Features.....	10
5.	Power Supply Connections .....	11
6.	Surface Leakage Current .....	13
7.	Guard Terminal Connection .....	13
8.	Improved Guard Terminal Connection .....	14
9.	Test Lead Connections.....	15
10.	Displayed Measured Insulation Resistance .....	21
11.	Viewing Stored Test Data.....	24
12.	IR Port on 1550C/1555 Insulation Tester .....	25



## ***Introduction***

The Fluke 1550C and 1555 Insulation Testers (hereafter “the Tester”) are high-voltage insulation testers to validate general circuits, such as switchgear, motors, and cables.

The Tester features:

- Large liquid crystal display (LCD)
- Six preset test voltages: 250 V, 500 V, 1000 V, 2500 V, 5000 V, 10,000 V (1555 only)
- Programmable test voltages: 250 V to 10,000 V (50/100 V steps)
- Resistance measurement: 200 k $\Omega$  to 2 T $\Omega$
- Polarization Index (PI)
- Dielectric Absorption Ratio (DAR)
- Ramp mode that linearly increases (100 V/s) the applied test voltage
- Test timer and storage for test results with user-defined ID tag
- Breakdown voltage indication
- Rechargeable lead-acid battery
- Auto shutoff after 30 minutes of inactivity
- Infrared (IR) port for downloading test data
- PC software (supplied)

The Tester meets EN 61557 Parts 1 and 2; and EN 61010-1, CAT IV 600 V Pollution Degree 2 standards. CAT IV equipment is designed to protect against transients from the primary supply level, such as an electricity meter or an overhead or underground utility service.

## **To Contact Fluke**

To contact Fluke, call one of the following telephone numbers:

- Technical Support USA: 1-800-44-FLUKE (1-800-443-5853)
- Calibration/Repair USA: 1-888-99-FLUKE (1-888-993-5853)
- Canada: 1-800-36-FLUKE (1-800-363-5853)
- Europe: +31 402-675-200
- Japan: +81-3-3434-0181
- Singapore: +65-738-5655
- Anywhere in the world: +1-425-446-5500

Or, visit Fluke's website at [www.fluke.com](http://www.fluke.com).

To register your product, visit <http://register.fluke.com>.

To see, print, or download the latest manual supplement, visit <http://us.fluke.com/usen/support/manuals>.

## **Safety Information**

**△△ Warning: Read before Tester use.**

To prevent possible electrical shock or personal injury, follow these guidelines:













- Before and after testing, confirm that the Tester does not indicate the presence of a hazardous voltage, see Figure 3. If the Tester beeps continuously and a hazardous voltage is shown on the display, remove power from the circuit under test or allow the installation capacitance to fully discharge.
- Use the Tester only as specified in this manual. Otherwise the protection provided by the Tester can be compromised.
- Connect the common test lead before the live test lead and remove the live test lead before the common test lead.
- Do not disconnect the test leads before a test has been completed and the test voltage at the terminals has returned to zero. This ensures that any charged capacitance is fully discharged.
- Disconnect circuit power and discharge all high-voltage capacitors before you measure resistance or capacitance.
- Do not work alone or around explosive gas, vapor or dust.
- Do not use the Tester in a damp or wet environment.
- Examine the test leads for damaged insulation or exposed metal. Check test lead continuity. Replace damaged leads. Do not use the Tester if it looks damaged.
- Be careful around voltages >30 V ac rms, 42 V ac peak, or 60 V dc. Such voltages pose a shock hazard.
- Keep fingers behind the finger guards on the probes.

- **Do not exceed the voltage or measurement category (CAT) rating of the test probes/accessories. Not all accessories provided are for use at the full-rated output voltage of the Tester. Accessories rated to 1000V CAT III/ 600V CAT IV are intended for hands-free use during insulation testing and are not to be touched while the output of the Tester exceeds the accessory's marked rating. Allow the Tester to fully discharge the installation before removing the test accessory.**
- **Impedances of additional operating circuits connected in parallel can adversely affect measurements.**
- **Place test leads in proper input terminals.**
- **Do not use the Tester with any parts or cover removed.**
- **Use only specified replacement parts in the Tester.**
- **Do not use the Tester if the safety shutter is impaired in any way. The safety shutter prevents access to the test terminals and charger terminals at the same time.**
- **There are no user replaceable parts inside the Tester.**
- **Use the guard terminal only as specified in this manual.**
- **Use only recommended test leads.**
- **Do not use in distribution systems with voltages higher than 1100 V.**

## Symbols

Symbols on the Tester and in the manual are explained Table 1.

**Table 1. Symbols**

Symbol	Meaning
	Conforms to European Union standards.
	Examined and licensed by TÜV Product Services.
	Canadian Standards Association is the certified body used for testing compliance to safety standards.
	Risk of Danger. Important information. See Manual.
	Hazardous voltage
	Equipment protected by double or reinforced insulation.
	Do not use in distribution systems with voltages higher than 1100 V.
	Interference is present. Displayed value might be outside of specified accuracy.
	Ramp mode indicator
	Electrical breakdown
	Volts AC
	Earth Ground
	Do not dispose of this product as unsorted municipal waste. Go to Fluke's website for recycling information.

## Unpack the Tester

The Tester comes with the items shown in Figure 1. If the Tester is damaged or an item is missing, immediately contact the place of purchase.

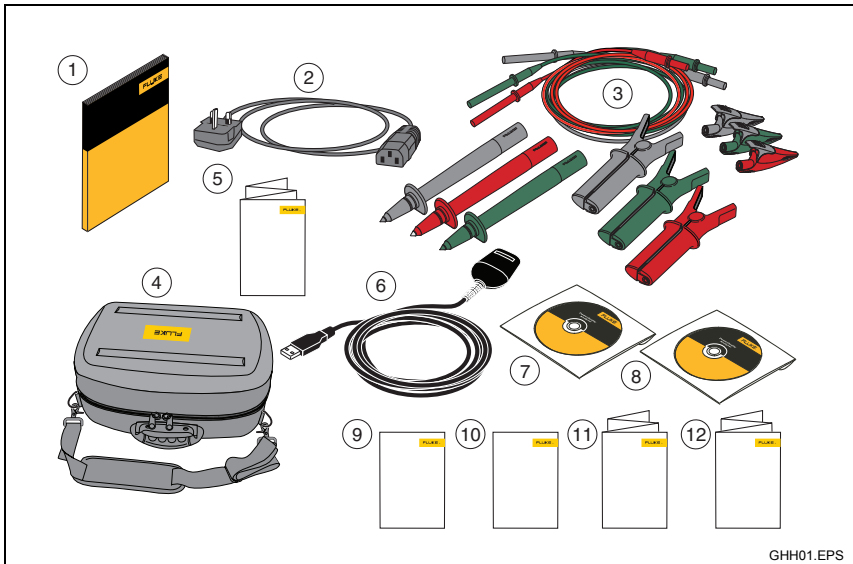

GH01.EPS

Item	Description
①	English Manual
②	AC Power Cord
③	⚠ Test Cables with Alligator Clips (red, black, green)
④	Soft Carrying Case
⑤	Quick Reference Card
⑥	Infrared adapter with interface cable
⑦	Users Manual on CD-ROM
⑧	FlukeView Forms Basic CD-ROM
⑨	Software License Agreement
⑩	Registration Card
⑪	FlukeView Forms Installation Guide
⑫	USB-IR Cable Installation Guide

Figure 1. Standard Items Provided



## **The Tester**

The subsequent sections tell you about the Tester and its operation. The Tester is shown in Figure 2.

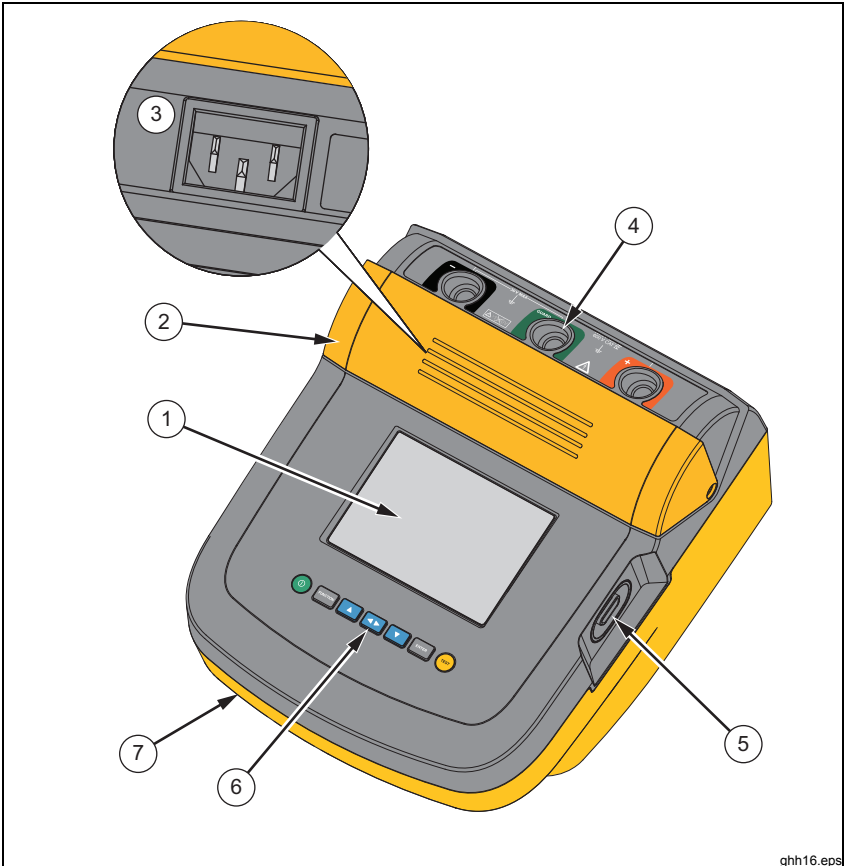

ghh16.eps

Item	Description	Item	Description
①	LCD	⑤	IR Port
②	Safety Shutter	⑥	Pushbuttons
③	AC plug	⑦	Built in Handle
④	Input Terminals		

**Figure 2. 1550C/1555 Insulation Tester**

## Pushbuttons

Use the pushbuttons to control the Tester, view test results, and scroll through chosen test results. Pushbuttons and their functionality are discussed in Figure 2.

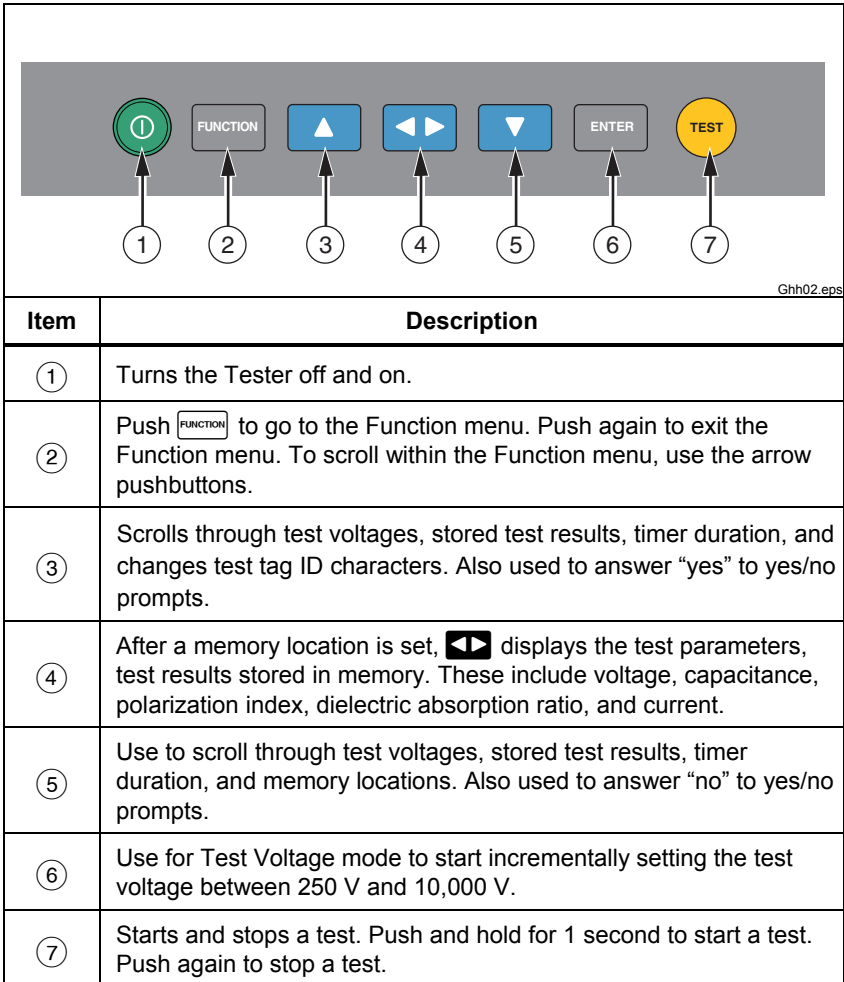

Figure 3. Pushbuttons

Additionally, ▲ and ▼ are also used to access the following menu items:

1.X Insulation Functions:

1.1 Ramp off (default)

1.2 Ramp on

1.3 DAR T= 01-00

1.4 DAR/PI T= 10-00

2 Time limit xx-xx

3 Show results

4 Delete results

Push  to make the selection.

### ***Turn the Tester On and Off***

Push  to turn on the Tester.

The Tester does a self-check, self-calibration, shows the current software version, and starts in the Test Voltage mode.

From here, you can:

- Change test parameters
- Start an insulation test
- View stored test results
- Download test results

Push  again to turn off the Tester.

## Display

Display annunciators are shown in Figure 4.

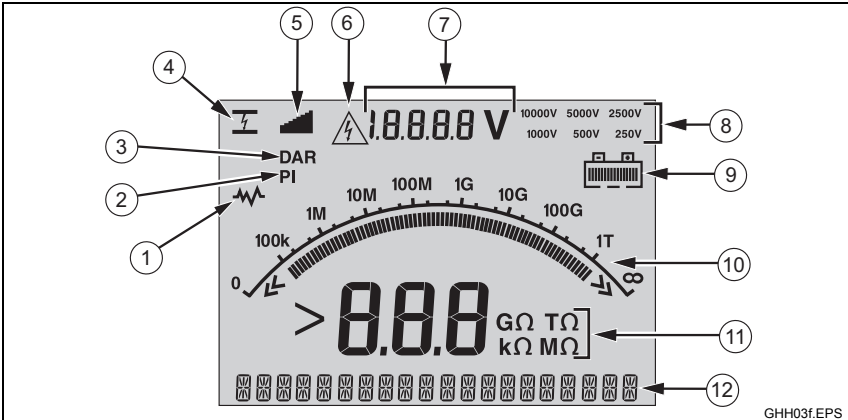

GHH03f.EPS

Item	Description
①	Interference present. Readings could be out of specified accuracy range.
②	Polarization Index.
③	Dielectric Absorption Ratio.
④	Electrical breakdown in Ramp mode.
⑤	Ramp mode indicator.
⑥	Possible hazardous voltage is at the test terminals. ⚡ ⚡ Warning: Before and after testing, confirm that the Tester does not indicate the presence of hazardous voltage. If the Tester beeps continuously and there is hazardous voltage, disconnect test leads and remove power from the circuit under test.
⑦	Voltage sourced by the Tester or from the circuit under test at terminals of the Tester.
⑧	Test voltage selection (250 V, 500 V, 1000 V, 2500 V, 5000 V, or 10,000 V).
⑨	Battery charge status.
⑩	Bar graph display of insulation resistance.
⑪	Digital display of insulation resistance.
⑫	Text display. Shows voltage, test current, capacitance, programmable test voltages, and menu options.

Figure 4. Display Features

## Charge the Battery

**Pb**  Note

*This Tester uses a rechargeable 12 V lead-acid battery for power. Do not mix with the solid waste stream. Use a qualified recycler or hazardous materials handler to discard dead batteries. Contact your approved Fluke Service Center for disposal and recycling data.*

*Storing rechargeable lead-acid batteries in a low-charged state could decrease their life and/or damage them. Fully charge the battery before storing it for extended periods and examine the charge at regular intervals.*

Charge the 12 V lead-acid battery with the ac power cord.

12 hours is typically necessary to fully charge the battery. Do not charge in very high or low temperatures. Charge the battery if the Tester is not used for extended periods. Figure 5 shows how to connect the Tester to a power supply.

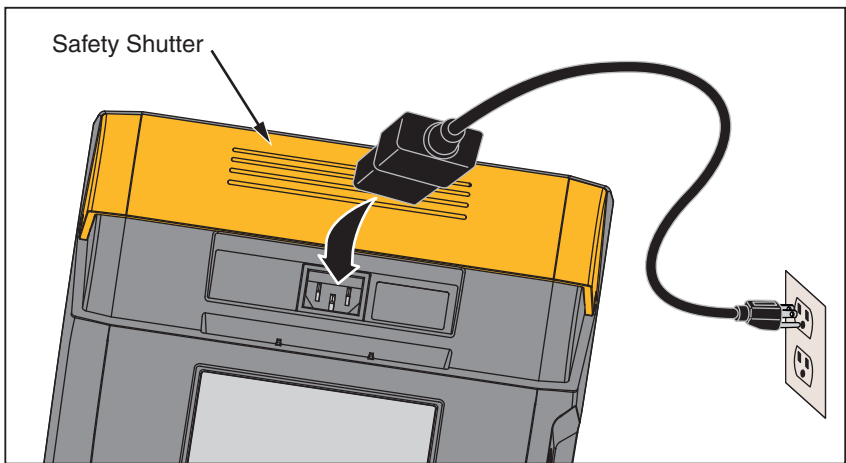

**Figure 5. Power Supply Connections.**

GHH11.EPS

To charge the battery with the ac power supply:

1. Turn the Tester off.
2. Disconnect the test leads from the Tester.
3. Move the safety shutter to access the power supply connection.
4. Connect the ac power cord to the IEC ac power socket on the Tester.
5. Connect the other end of the power cord to an ac power supply. See “General Specifications” for ac charger input specifications.

The LCD displays **CHARGING**. Downloading is possible when the Tester is in Charging mode.

## **Guard Terminal Use**

### *Note*

*Insulation resistance is measured between the (+) and (–) output connections. The Guard terminal (G) is at the same potential as the negative (–) terminal but is not in the measurement path.*

For most tests, only two test leads are used. Connect the positive (+) and negative (–) test leads to the corresponding inputs on the Tester. Connect the test lead probes to the circuit under test. The Guard (G) terminal is left unconnected.

For the best accuracy when you measure very high resistances, use three-wire measurements and the Guard terminal. The Guard terminal is at the same potential as the negative (–) terminal, and can be used to prevent surface leakage or other unwanted leakage currents from degrading the accuracy of the insulation resistance measurement.

Figure 6 shows how to measure the resistance from one of the conductors to the outer shield. In this case, there is a leakage current along the surface of the inner insulation near the cables end. This leakage adds to the current that the negative terminal senses, and causes the Tester to read a lower resistance than it should.

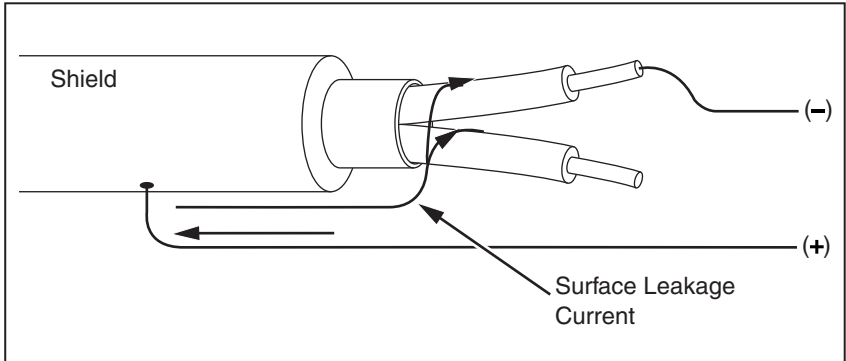

GHH13.EPS

**Figure 6. Surface Leakage Current**

Figure 7 shows how to prevent surface current leakage with a lead connected from the Guard terminal to a conductor that surrounds the inner insulation. The surface leakage current is directed to the Guard terminal. This removes the leakage current from the measurement path between the positive and negative terminals, and improves the accuracy of the test readings.

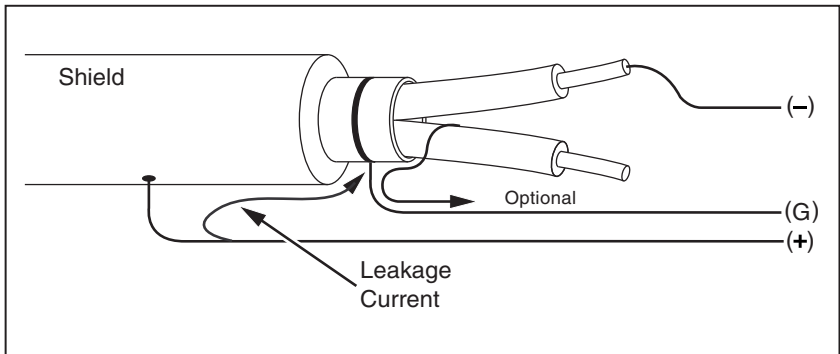

GHH14.EPS

**Figure 7. Guard Terminal Connection**

Figure 8 shows how make the measurement setup better. Connect the Guard terminal to the unused wire and attach it to the inner insulation. This ensures that the Tester measures the leakage between the selected conductor and the outer shield, but removes the leakage path between conductors.

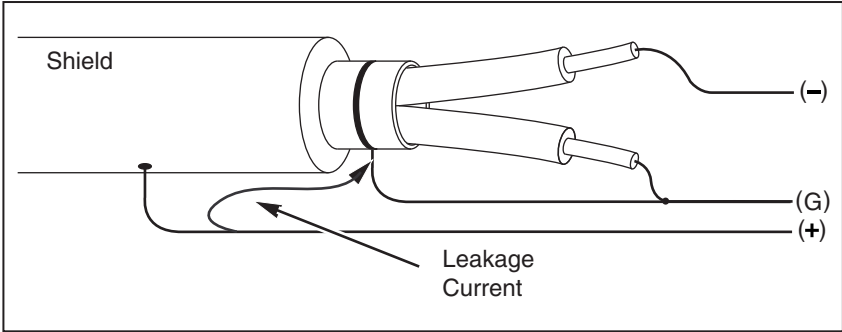

GHH16.EPS

Figure 8. Improved Guard Terminal Connection

## Measurements

Common measurement procedures are discussed in this section.

### Connect to the Circuit Under Test

#### ⚠⚠ Warning

To avoid possible electric shock or personal injury:

- Remove all power from the circuit under test and discharge circuit capacitance before testing a circuit with the Tester.
- Connect the common test lead before the live test lead and remove the live test lead before the common test lead.
- Before and after testing, confirm that the Tester does not indicate the presence of a hazardous voltage, see Figure 4. If the Tester beeps continuously and a hazardous voltage is shown on the display, remove power from the circuit under test and disconnect test leads.



To connect to the circuit under test:

1. Move the safety shutter to access the input terminals.
2. Put the test leads into the correct terminals shown, see Figure 9.
3. Connect the test leads to the circuit under test.

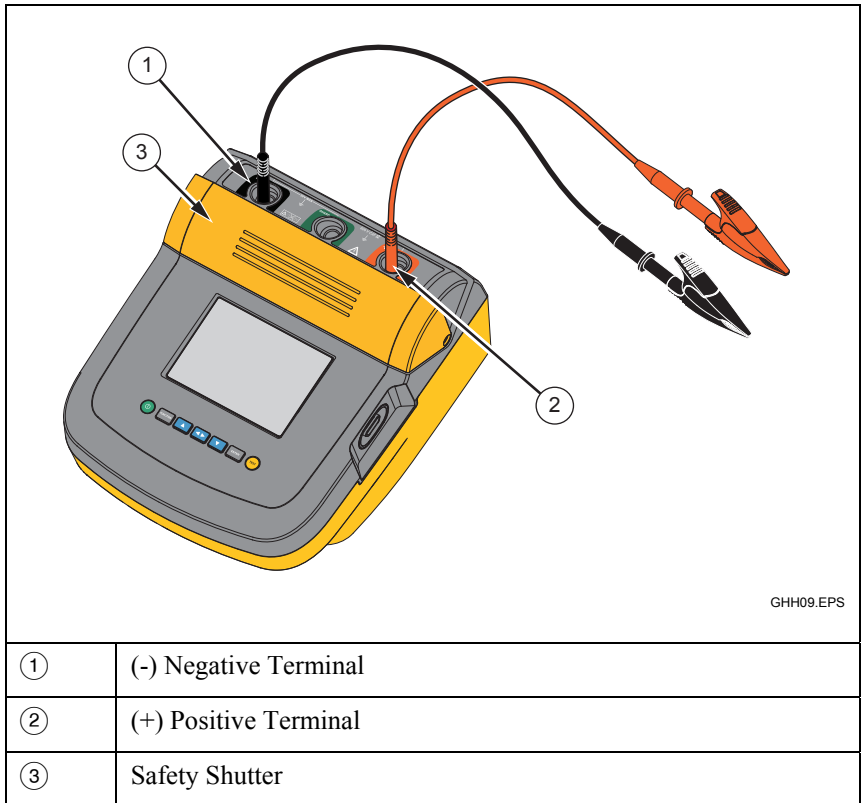

**Figure 9. Test Lead Connections**

*Note*

*The Tester is NOT specified below 200 k $\Omega$ . When the leads are shorted and a test is performed, the Tester gives an unspecified reading that is greater than zero. This is normal for this Testers input circuitry configuration and does not change readings that are in the specified accuracy range.*

## Before an Insulation Test

The Tester includes features and functions that let you adapt the test to your requirements. These features let you:

- define a test voltage
- make a ramp test selection
- set a time limit (duration) for the test
- measure polarization index (PI)
- measure dielectric absorption ratio (DAR)
- measure capacitance

Use these alone or in combination. Set, clear, or account for (as appropriate) each feature before you start an insulation test. The features are discussed in this section.



### Preset Test Voltage Selection

To make a preset test voltage selection:

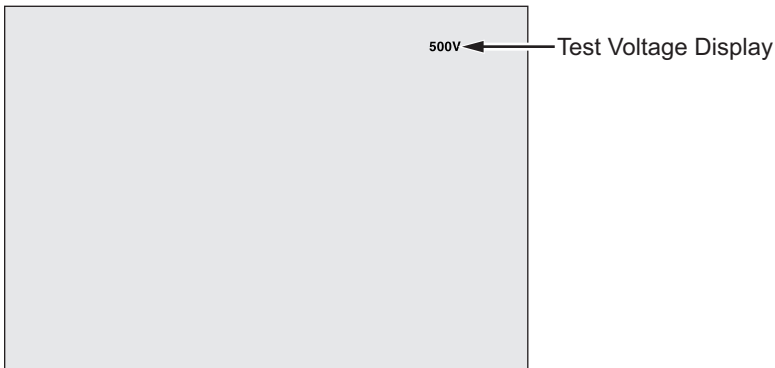
1. With the Tester turned on, push  to select **TEST VOLTAGE**.



GHH05.EPS

2. Push  or  to scroll through the preset test voltage options (250 V, 500 V, 1000 V, 2500 V, 5000 V, and 10,000 V).

The test voltage selection shows in the upper-right of the display.

*Note*

*The actual test voltage can be up to 10 % higher than the selected test voltage.*





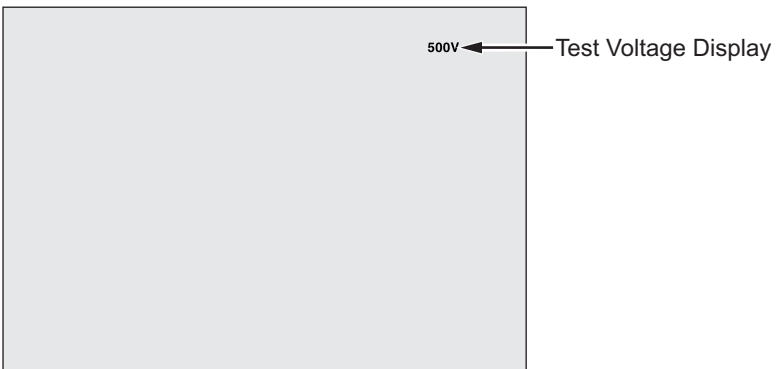

### **Program a Test Voltage**

To set a test voltage in between the preset test voltages, proceed as follows:

1. With the Tester turned on, push  to select **TEST VOLTAGE**.



GHH05.EPS

2. Push  or  to scroll through the preset test voltage options (250 V, 500 V, 1000 V, 2500 V, 5000 V, and 10,000 V). Select the voltage closest to the level required.
3. The selected test voltage appears in the upper-right of the display.
4. Push . **TV=xxxxV** appears flashing in the lower-left of the display.
5. Push  or  to increment and decrement the voltage. When the correct voltage level shows, **do not** push . Doing so will return the test voltage to the next lowest last preset voltage selection. Instead, push  to go to the function menu.

*Note*

*The test voltage can be up to 10 % higher than the test voltage you select.*

## Select a Ramp or Steady-State Test

The ramp-test function is an automated test that checks insulation for a breakdown. During a ramp test, the output voltage starts at 0 V and increases linearly (100 V/s) until it reaches the specified test voltage or until a sudden drop in measured resistance is detected. Then, the Ramp stops, the test voltage drops to zero, and the voltage at the breakdown point is stored in memory on the Tester. All other test results are declared invalid if the test does not reach the specified test voltage. If the test successfully meets compliance without breakdown, then the only valid test results are test voltage and insulation resistance.

To enable or disable the ramp function:

1. With the Tester turned on, push **FUNCTION** to enter the 1.X Function Menu.
2. Push **ENTER** to call the menu item.

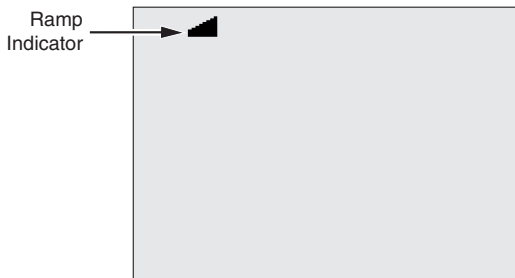

GHH07.EPS







3. Push **▲** or **▼** to toggle the Ramp on or off. When the ramp is on a blinking  appears in the upper left-hand corner of the display.
4. Push **ENTER** or **TEST** to use the settings. **TEST** starts the test.

## Set a Timed Test

You can control the length of an insulation test by setting a timer. The time (test duration) can be set in 1-minute increments up to 99 minutes. During a timed test, the time limit appears on the right bottom of the display, and the elapsed time is shown in the middle of the display. At the end of the elapsed time, the insulation test has been completed and the test is terminated.

To set a test time limit:

1. With the Tester turned on, push **FUNCTION** to enter the Function Menu.
2. Push **▲** or **▼** to select the **2.Time Limit** function.

3. Push  to call the menu item.
4. Push  or  to select the time.
5. Push  or  to use the settings.  starts the test.

### *Polarization Index (PI)*

As part of the insulation test, the Tester measures and stores polarization index (PI), when appropriate. A polarization index test requires 10 minutes to complete. Therefore, the Tester will start a countdown at 10 minutes. When an insulation test is 10 minutes or more, the polarization test is completed and stored. The results are available for display during a test by pushing the  button or by storing the test results and scanning the **RESULTS** fields. The field is identified by **PI**.

$$PI = \frac{R \times 10 \text{ min}}{R \times 1 \text{ min}}$$

### *Dielectric Absorption Ratio*

As part of the insulation test, the Tester measures and stores dielectric absorption ratio (DAR), when appropriate. A DAR test requires 1 minute to complete. Therefore, it is measured and stored as invalid data for all insulation tests less than 1 minute. When an insulation test is 1 minute or more the DAR test is included in the results. The results are available for display during a test by pushing the  button or by storing the test results and scanning the **RESULTS** fields. The field is identified by **DAR**.

$$DAR = \frac{R \times 1 \text{ min}}{R \times 30 \text{ sec}}$$

### *Capacitance*

As part of the insulation test, the Tester measures and stores capacitance when appropriate. The results are available for display during a test by pushing the  button or by storing the test results and scanning the **RESULTS** fields. The field is identified by **C**.

## Insulation Test

### Warning

To avoid possible electric shock or personal injury:

- **Be aware that measuring insulation resistance requires the application of potentially dangerous voltages to the circuit. This may include exposed bonded metalwork.**
- **Remove all power from the circuit under test and discharge circuit capacitance before testing a circuit with the Tester.**
- **Before proceeding, ensure that the installation is wired correctly and no personnel are endangered by any tests.**
- **First connect the test leads to the Tester inputs before you make connection to the circuit under test.**

PI/DAR Limits:

- Cap. Mdx > 1  $\mu$ F and Res. Max > 100 M $\Omega$
- Res. Min < 200 k  $\Omega$
- Current min < 50  $\mu$ A
- If one of the limits is beyond, the Tester will display UNSPEC.

To perform an insulation test:

1. With the Tester turned on, set the available measurement options to meet your test requirements. These include:
  - Test Voltage – Set range: 250 V to 10,000 V (50 V/100 V steps)
  - Ramp Test – Toggle on or off
  - Time Limit – No limit or from 1 to 99 minutes
2. Connect the probes to the circuit under test.

**⚠ ⚠ Warning**

**Before and after testing, confirm that the Tester does not indicate the presence of a hazardous voltage, see Figure 4. If the Tester beeps continuously and a hazardous voltage is shown on the display, disconnect test leads and remove power from the circuit under test.**

3. Push  $\text{TEST}$  for 1 second to start the insulation test.

The Tester beeps three times as the test begins, and  $\Delta$  flashes on the display indicating potentially hazardous voltages may be present on the test terminals.

The display indicates the measured insulation resistance after the circuit has stabilized. The bar graph displays this value continuously (in real time) as a trend, see Figure 10.

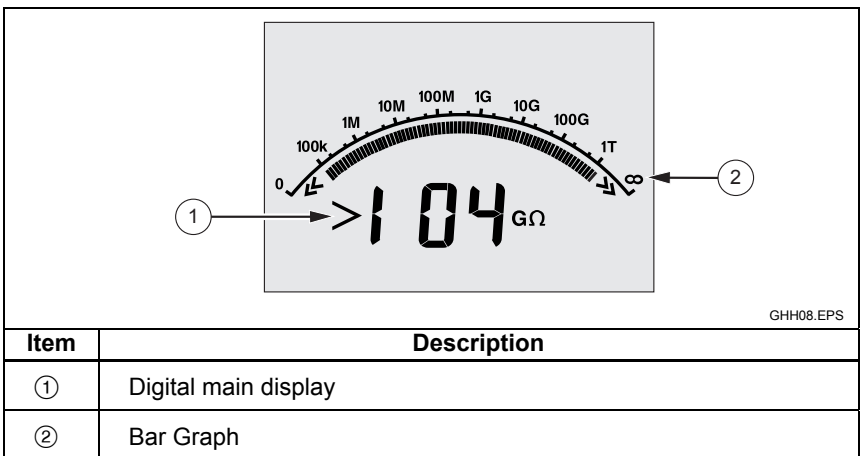

**Figure 10. Displayed Measured Insulation Resistance**

Any of the following conditions will terminate an insulation test:

- User stop (pushing  $\text{TEST}$ )
- Timer limit reached
- Interference on the test circuit
- Breakdown occurs with ramp test enabled
- Battery depleted

If breakdown occurs with ramp test enabled, push  before going to step 4.







Following termination of an insulation test, the Tester beeps when a potentially hazardous voltage remains on the test terminals due to charged-circuit capacitance or from the presence of an external voltage.

4. When the test is terminated, **STORE RESULT?** Is displayed. If appropriate, store the test results as described in the next procedure. Otherwise, terminate the **STORE RESULT?** Prompt by pushing . The results are not stored.

### **Store Test Results**

Upon completion of an insulation test, the Tester displays **STORE RESULT?** As a prompt to save the measurement results for future use. The Tester includes enough memory to store the results of 99 insulation tests for future use.

To store the results of an insulation test:

1. Push  to save the measurement results. The Tester will assign and display a sequential tag number (00 to 99) to identify the measurement.
2. If the tag number is acceptable, push  to store the data. If a different tagging convention is required, proceed as follows to provide a custom 4-character tag.
  - a. Notice that \* is blinking on the display. This is the first of the four characters available for tagging the test results. Repeatedly push  to cycle through the character positions.
  - b. At each character position use  or  to assign a character (0-9, A-Z).
  - c. Push  to store the results.



## **View Results Stored in Memory**





### *Note*

*Parameters not appropriate for a test are shown as **INVALID**.*

The Tester can store 99 sets of test data, including:

- Tags
- Ramp on or off
- Insulation Resistance
- Timer reading at termination of test (Timer)
- Test Voltage Selected (TV)
- Actual Test voltage (V)
- Capacitance I
- Polarization Index (PI)
- Dielectric absorption ratio (DAR)
- Test current (I)
- Reason for ending the test
- Limit – off or timer setting (1 to 99 minutes) (T. Limit)

To view stored test data, see Figure 11:

1. With the Tester turned on, push  to call the Function menu.
2. Push  or  to select **3. Show Results**.
3. Push  to select the menu item.

### *Note*

*When a voltage is present at the terminals, that voltage is always shown on the top-center of the display, regardless of whether that voltage is sourced by the Tester or is from the circuit under test.*

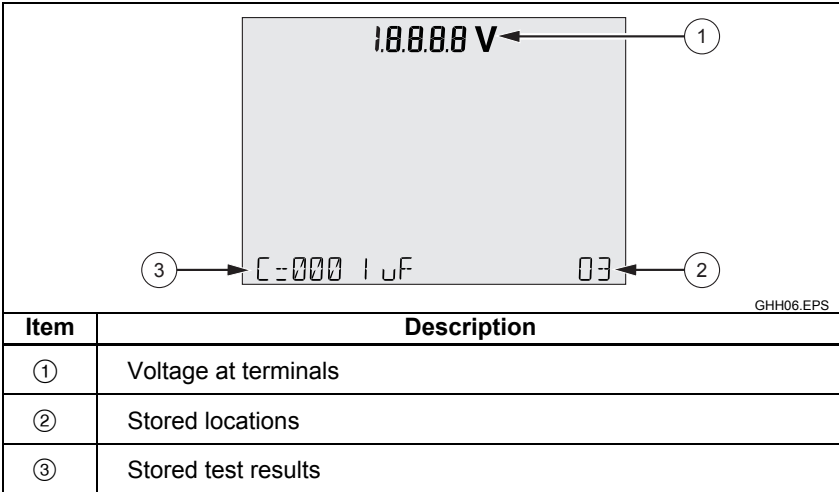
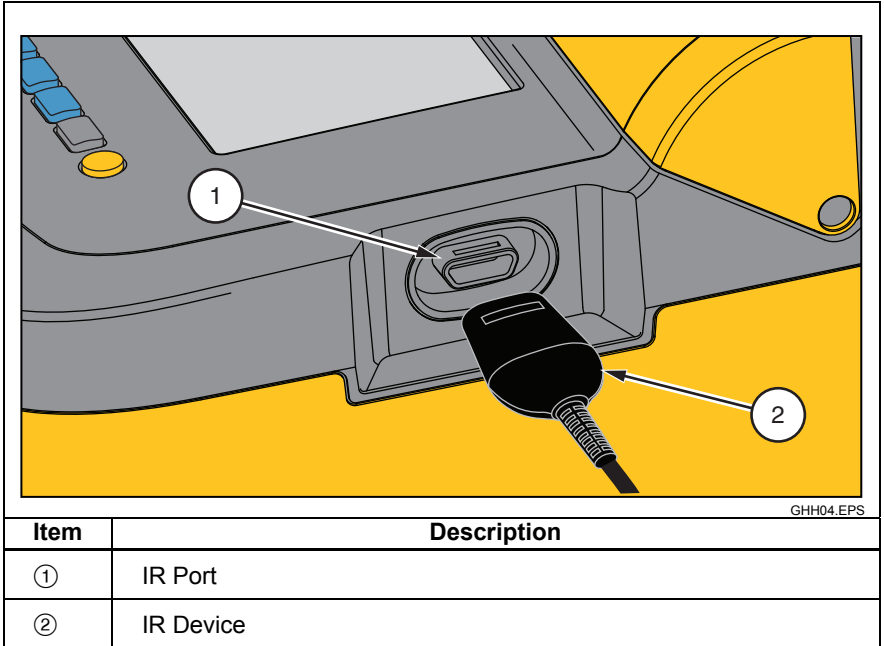

**Figure 11. Viewing Stored Test Data**

4. Push **▲** or **▼** to step through the stored locations.
5. Stop at the location you want to view.
6. Push **▶◀** to view the stored test data for a specific test. Test data appears on the alphanumeric text display and on the LCD.
7. Push **ENTER** to call the menu selection.

### **Download Your Test Results**

You can use FlukeView Forms software to download all of your stored test data to a PC. An infrared adapter is supplied with the Tester for use in downloading stored test data. Figure 10 shows the location of the IR port on the Tester.



**Figure 12. IR Port on 1550C/1555 Insulation Tester**

### ***Install FlukeView Forms Basic Software***

FlukeView Forms Basic software must be installed on your PC to download stored test data.

To install FlukeView Forms Basic, see the *FlukeView Forms Installation Guide*.

To install the infrared adapter, see the *USB-IR Cable Installation Guide*.

## Download Results to PC

### Note

*Before the USB-IR cable can be used, software drivers must be installed on your Windows PC. See the USB-IR Installation Guide for more information.*

To connect the Tester to the PC for use with *FlukeView Forms Basic Documenting Software*:

The Tester should not be running a test; otherwise, serial communications will be disabled.

1. Connect the USB-IR cable to an available USB port on the PC.
2. Attach the IR device to the IR port on the Tester.
3. Open *FlukeView Forms Basic Documenting Software*.
4. The current COM serial port setting is displayed at the bottom right of the *FlukeView Forms Basic* window. Double-click on it to change the COM port setting to the virtual COM port used by the USB-IR cable.
5. Turn the Tester on.
6. Follow the instructions for transferring data from the Tester to the PC found in the online *FlukeView Forms Users Manual*.

### Note







*Verify that the download was successful before deleting the stored test results on the Tester.*

### Note

*Results data stored in the Tester can be deleted from the PC using the *FlukeView Forms Basic* application. See the *FlukeView Forms Users Manual* file for details.*

## Delete Test Results

To delete all saved test results:

1. Push  to call the Function menu.
2. Push  or  to select the menu item **DELETE RESULT**.
3. Push  to call the menu item.
4. Push . **REALLY DEL?** Appears.
5. Push  to confirm the deletion or push  to return to **Test Voltage**.

*Notes*

*Individual test locations cannot be deleted; however, they can be overwritten.*

*The Delete function deletes all stored test results.*

## **Maintenance**

### **⚠⚠ Warning**

**To avoid possible electric shock or personal injury:**

- **Do not attempt to repair or service your Tester beyond what is described in this manual.**
- **Only qualified service personnel should service the Tester.**
- **There are no user-replaceable parts inside the Tester.**

## **Cleaning**

### **⚠⚠ Warning**

**To avoid possible electric shock or personal injury, remove excess water from the cloth before cleaning the Tester to ensure that water does not enter any terminal.**

Periodically wipe the case with a damp cloth and mild detergent. Do not use abrasives or solvents to clean the Tester.

## **Replaceable Parts and Accessories**

Table 2 lists the replaceable parts that are available for the Tester. Table 3 identifies the accessories available for use with the Tester.

**Table 2. List of Replaceable Parts**

<b>Parts</b>	<b>Part No.</b>
Test Lead – Red	1642584
Test Lead – Black	1642591
Test Lead – Green	1642600
Test Clip – Red	1642617
Test Clip – Black	1642621
Test Clip – Green	1642639
AC Power Cord (North America)	284174
AC Power Cord (Continental Europe)	769422
AC Power Cord (UK)	769455
AC Power Cord (Australia)	658641
AC Power Cord (S. Africa)	1552363
Soft Carrying Case	3592805
Infrared Cable Assembly	1578406
Users Manual CD-ROM	3592810
English Users Manual	3593019
Quick Reference Card	3592822



**Table 3. Accessories**

<b>Accessories</b>	<b>Part No.</b>
Extended Test Lead Set, 25 feet (7.6 meters)	2032761
Rugged Alligator Clamps	3611951
Soft Case	3592805
Hard Case	3671624

## Specifications

### General Specifications

<b>Display</b>	75 mm x 105 mm
<b>Power</b>	12 V lead-acid rechargeable battery. 2.6 Ahr
<b>Charger Input (AC)</b>	85 V to 250 V ac, 50/60 Hz, 20 VA This Class II (double insulated) instrument is supplied with a Class 1 (grounded) power cord. The protective earth terminal (ground pin) is not connected internally. <u>The extra pin is for added plug retention only.</u>
<b>Dimensions (H x W x L)</b>	170 mm x 242 mm x 330 mm (6.7 in. x 9.5 in. x 13.0 in.)
<b>Weight</b>	3.6 kg (7.94 lbs.)
<b>Temperature (operating)</b>	-20 °C to 50 °C (-4 °F to 122 °F)
<b>Temperature (storage)</b>	-20 °C to 65 °C (-4 °F to 149 °F)
<b>Relative Humidity</b>	80 % to 31 °C decreasing linearly to 50 % at 50 °C
<b>Altitude</b>	2000 m
<b>Enclosure Sealing</b>	IP40
<b>Input Overload Protection</b>	1000 V ac

<b>Electromagnetic Compatibility</b>	EN 61326-1, EN 61326-2-2	
<b>Certifications</b>	  	
<b>Safety Compliance</b>	EN 61010-1, EN 61557 Parts 1 and 2 CAT III 1000V, CAT IV 600V	
<b>Pollution Degree</b>	2	
<b>Typical Battery Charge Capability</b>  Note At temperature extremes, the battery needs to be charged more frequently.	<b>Test Voltages</b>	<b>Number of Tests</b>
	250 V	4100
	500 V	3600
	1 kV	3200
	2.5 kV	2500
	5 kV	1000
	10 kV	500

### Electrical Specifications

The Tester’s accuracy is specified for 1 year after calibration at operating temperatures of 0 °C to 35 °C. For operating temperatures outside the range (-20 °C to 0 °C and 35 °C to 50 °C), add ±0.25 % per °C, except on the 20 % bands add ±1 % per °C.

Insulation		
Test Voltage (DC)	Insulation Resistance Range	Accuracy (±reading)
250 V	< 200 kΩ	unspecified
	200 kΩ to 5 GΩ	5 %
	5 GΩ to 50 GΩ	20 %
	> 50 GΩ	unspecified
500 V	< 200 kΩ	unspecified
	200 kΩ to 10 GΩ	5 %
	10 GΩ to 100 GΩ	20 %
	> 100 GΩ	unspecified



**Insulation Tester**  
**Specifications**

1000 V	< 200 k $\Omega$ 200 k $\Omega$ to 20 G $\Omega$ 20 G $\Omega$ to 200 G $\Omega$ > 200 G $\Omega$	unspecified 5 % 20 % unspecified
2500 V	< 200 k $\Omega$ 200 k $\Omega$ to 50 G $\Omega$ 50 G $\Omega$ to 500 G $\Omega$ > 500 G $\Omega$	unspecified 5 % 20 % unspecified
5000 V	< 200 k $\Omega$ 200 k $\Omega$ to 100 G $\Omega$ 100 G $\Omega$ to 1 T $\Omega$ > 1 T $\Omega$	unspecified 5 % 20 % unspecified
10,000 V	< 200 k $\Omega$ 200 k $\Omega$ to 200 G $\Omega$ 200 G $\Omega$ to 2 T $\Omega$ > 2 T $\Omega$	unspecified 5 % 20 % unspecified
Bar graph range: Insulation test voltage accuracy: Induced ac mains current rejection: Charging rate for capacitive load:		0 to 2 T $\Omega$ -0 %, +10 % at 1 mA load current 2 mA maximum 5 seconds per $\mu$ F
Discharge rate for capacitive load:		1.5 s/ $\mu$ F

Leakage Current Measurement	Range	Accuracy
	1 nA to 2 mA	$\pm$ (20 % + 2 nA)
Capacitive Measurement	0.01 $\mu$ F to 20.00 $\mu$ F	$\pm$ (15 % of reading + 0.03 $\mu$ F)

Timer	Range	Resolution
	0 to 99 minutes	Setting: 1 minute Indication: 1 second

Live circuit warning	Warning Range	Voltage Accuracy
	30 V to 1100 V ac/dc, 50/60 Hz	$\pm$ (15 % + 2 V)

Short circuit current > 1 mA and < 2 mA

## **Principle of Measurement and Resistance**

The Tester measures insulation parameters and displays the results using with the following formulas.

<b>Ohm's Law</b>	<b>Capacitance (charge)</b>	<b>PI (Polarization Index)</b>	<b>DAR (Dielectric absorption ratio)</b>
$R = \frac{V}{I}$	$C = \frac{Q}{V}$	$PI = \frac{R \times 10 \text{ min}}{R \times 1 \text{ min}}$	$DAR = \frac{R \times 1 \text{ min}}{R \times 30 \text{ s}}$