

FLUKE®

753/754

Documenting Process Calibrator

Users Manual

July 2011 Rev. 1, 8/12

© 2011-2012 Fluke Corporation. All rights reserved. Specifications are subject to change without notice.
All product names are trademarks of their respective companies.

Shop for Fluke products online at: www.MyFlukeStore.com 1.877.766.5412

LIMITED WARRANTY AND LIMITATION OF LIABILITY

This Fluke product will be free from defects in material and workmanship for three years from the date of purchase. This warranty does not cover fuses, disposable batteries, or damage from accident, neglect, misuse, alteration, contamination, or abnormal conditions of operation or handling. Resellers are not authorized to extend any other warranty on Fluke's behalf. To obtain service during the warranty period, contact your nearest Fluke authorized service center to obtain return authorization information, then send the product to that Service Center with a description of the problem.

THIS WARRANTY IS YOUR ONLY REMEDY. NO OTHER WARRANTIES, SUCH AS FITNESS FOR A PARTICULAR PURPOSE, ARE EXPRESSED OR IMPLIED. FLUKE IS NOT LIABLE FOR ANY SPECIAL, INDIRECT, INCIDENTAL OR CONSEQUENTIAL DAMAGES OR LOSSES, ARISING FROM ANY CAUSE OR THEORY. Since some states or countries do not allow the exclusion or limitation of an implied warranty or of incidental or consequential damages, this limitation of liability may not apply to you.

Fluke Corporation
P.O. Box 9090
Everett, WA 98206-9090
U.S.A.

Fluke Europe B.V.
P.O. Box 1186
5602 BD Eindhoven
The Netherlands

11/99

Table of Contents

Title	Page
Introduction	1
How to Contact Fluke	1
Safety Information	2
Standard Equipment.....	6
Functions.....	9
Get Started	11
Operation Features	13
Input and Output Jacks.....	13
Buttons	15
Display.....	18
Strap and Stand.....	21
The Battery.....	22
Charge the Battery	22
Battery Charge Level.....	23
Battery Life	23

Preserve Battery Life	25
The Battery Charger	25
Display Languages	26
Display Intensity.....	26
Date and Time	26
The Backlight.....	28
Personalize the Product.....	28
Measure Mode.....	29
Measurement Ranges.....	29
Electrical Parameter Measurement.....	30
Continuity Test.....	32
Pressure Measurement.....	32
Temperature Measurement	36
Thermocouple Use.....	36
Resistance-Temperature Detectors (RTDs).....	39
Measurement Scale	43
Linear-Output Transmitters	43
Square-Law Process Variables	43
Measure or Source with Custom Units.....	44
Using the 700-IV Current Shunt.....	44
Damping Measurements.....	45
Source Mode	45
Source Electrical Parameters	45
4 to 20 mA Transmitter Simulation.....	48
Supply Loop Power.....	50
Source Pressure	52
Thermocouple Simulation	55
RTD Simulation.....	56
Source Temperature with a Hart Scientific Drywell.....	59

Source Scale	61
Linear-Responding Transmitters.....	61
Square-Root Process Variables.....	61
Step and Ramp the Output Value.....	62
Manual Step Use	62
Auto Step Use.....	62
Ramp the Output	63
Simultaneous Measure/Source	66
Process Instrument Calibration	69
Generate “As Found” Test Data	69
Transmitter Adjustment	74
“As Left” Test Run	75
Test Comments	75
Calibrate a Delta-Pressure Flow Instrument.....	75
Switch Calibration.....	76
Transmitter Mode	79
Memory Operations.....	80
Save Results	80
Review the Memory.....	83
Log Data.....	83
Record Min and Max Measurements.....	86
Run a Preloaded Task.....	87
Clear the Memory.....	87
The Calculator	87
Save to and Recall from the Registers	88
Use the Calculator to Set the Source Value	88
Quick Guide to Applications	88
Communication with a PC	101
Maintenance.....	101

Battery Replacement	101
Clean the Product	101
Calibration Data	102
In Case of Difficulty	102
Service Center Calibration or Repair	102
User-Replaceable Parts	102
Accessories	104
Specifications	106
General Specifications	106
Environmental Specifications	106
Standards and Agency Approval Specifications	106
Detailed Specifications	107
DC mV Measurement	107
DC Voltage Measurement	108
AC Voltage Measurement	108
DC Current Measurement	109
Resistance Measurement	109
Continuity Testing	109
Frequency Measurement	110
±DC Voltage Output	110
+DC Current Source	111
+DC Current Simulate (External Loop Power)	111
Resistance Sourcing	111
Frequency Sourcing	112
Temperature, Thermocouples	113
Temperature, Resistance Temperature Detectors	116
Loop Power	117

List of Tables

Table	Title	Page
1.	Symbols.....	4
2.	Summary of Source and Measure Functions	10
3.	Input/Output Jacks and Connectors	13
4.	Buttons	16
5.	Elements of a Typical Display	20
6.	Typical Battery Life	23
7.	Thermocouple Types Accepted	37
8.	RTD Types Accepted	39
9.	Simultaneous MEASURE/SOURCE Functions with Loop Power Disabled	67
10.	Simultaneous MEASURE/SOURCE Functions with Loop Power Enabled	68
11.	Duration Limits	84
12.	Replacement Parts	103

List of Figures

Figure	Title	Page
1.	Standard Equipment.....	7
2.	Jumper Connections	12
3.	Measure/Source Example	12
4.	Input/Output Jacks and Connectors	14
5.	Buttons	15
6.	Elements of a Typical Display	19
7.	Stand Use and Strap Attachment	21
8.	Battery Removal and Charger Use.....	24
9.	Time and Date Display	27
10.	Edit the Date Format	27
11.	Personalize the Product	28
12.	Electrical Measurement Connections	31
13.	Gage and Differential Pressure Modules.....	33
14.	Pressure Measurement Connections	35
15.	Temperature Measurement with a Thermocouple	38

16.	Correct Jumper Use.....	41
17.	Temperature Measurement with an RTD.....	42
18.	Electrical Source Connections.....	47
19.	Connections fo Simulate a 4 to 20 mA Transmitter.....	49
20.	Connections to Supply Loop Power.....	51
21.	Connections to Source Pressure.....	54
22.	Connections to Simulate a Thermocouple.....	57
23.	Connections to Simulate an RTD.....	58
24.	Source Temperature with Drywell.....	60
25.	Ramp Screen.....	64
26.	Check a Relay Output Trip Alarm.....	65
27.	Measure and Source Screen.....	66
28.	Process Instrument Calibration Screen.....	70
29.	Process Instrument Calibration Screen 2.....	70
30.	Calibrate a Thermocouple Temperature Transmitter.....	71
31.	Calibration Parameters Screen.....	72
32.	Measure and Source Screen for Calibration.....	73
33.	Error Summary Screen.....	73
34.	As Left Data Screen.....	75
35.	Switch Terminology.....	76
36.	Saved Data Screen.....	81
37.	Additional Data Input Screen.....	81
38.	Alphanumeric Entry Window.....	82
39.	Memory Review Screen.....	83
40.	Data Log Parameters Screen.....	83
41.	Start Logging Screen.....	85
42.	Min Max Screen.....	86
43.	Chart Recorder Calibration.....	89
44.	Voltage Drop Measurement.....	89

45.	Monitor AC Line Voltage and Frequency	90
46.	Current-to-Pressure (I/P) Transmitter Calibration	91
47.	Output Current of a Transmitter Measurement	92
48.	Precision Resistor Measurement	93
49.	Resistance Source	93
50.	Checking a Switch	94
51.	Tachometer Examination	94
52.	Analog and HART Pressure Transmitter Connection	95
53.	mV to Current Transmitter Calibration	96
54.	Vortex Shedding Flowmeter Check	97
55.	HART and Analog RTD Transmitter Connections	98
56.	Analog and HART Thermocouple Transmitter Connections	99
57.	Transmitter HART- Comm Only	100

Introduction

The 753 and 754 Documenting Process Calibrators (the Product) are battery-powered, hand-held instruments that measure and source electrical and physical parameters. In addition, the 754 supplies basic HART[®] communicator functions when used with HART-capable transmitters. See the *754 HART Mode Users Guide* for instructions on how to use the HART communication feature.

The Product helps troubleshoot, calibrate, verify, and document work performed on process instruments.

Note

All figures in this manual show the 754.

How to Contact Fluke

To contact Fluke, call one of the following telephone numbers:

- Technical Support USA: 1-800-44-FLUKE (1-800-443-5853)
- Calibration/Repair USA: 1-888-99-FLUKE (1-888-993-5853)
- Canada: 1-800-36-FLUKE (1-800-363-5853)
- Europe: +31 402-675-200
- Japan: +81-3-6714-3114
- Singapore: +65-6799-5566
- Anywhere in the world: +1-425-446-5500

Or, visit Fluke's website at www.fluke.com.

To register your product, visit <http://register.fluke.com>.

To view, print, or download the latest manual supplement, visit <http://us.fluke.com/usen/support/manuals>.

The latest software trial version of *DPCTrack2* can be downloaded at www.fluke.com/DPCTrack. For more information see "Communication with a PC".

753/754 Accessories can be found at www.fluke.com/process_acc.

Safety Information

A **Warning** identifies conditions and actions that pose hazards to the user; a **Caution** identifies conditions and actions that may damage the Product or the equipment under test.

Warning

To prevent personal injury, use the Product only as specified, or the protection supplied by the Product can be compromised.

To prevent possible electrical shock, fire, or personal injury:

- Read all safety Information before you use the Product.
- Carefully read all instructions.
- Use only correct measurement category (CAT), voltage, and amperage rated probes, test leads, and adapters for the measurement.
- The battery must be locked in place before you operate the Product.
- Recharge the battery when the low battery indicator shows to prevent incorrect measurements.
- Do not apply more than the rated voltage, between the terminals or between each terminal and earth ground.
- Limit operation to the specified measurement category, voltage, or amperage ratings.
- Do not exceed the Measurement Category (CAT) rating of the lowest rated individual component of a Product, probe, or accessory.
- Measure a known voltage first to make sure that the Product operates correctly.
- Do not touch voltages > 30 V ac rms, 42 V ac peak, or 60 V dc.
- Do not use the Product around explosive gas, vapor, or in damp or wet environments.
- Do not use and disable the Product if it is damaged.
- Do not use the Product if it operates incorrectly.
- Keep fingers behind the finger guards on the probes.
- Remove all probes, test leads, and accessories that are not necessary for the measurement.
- Only use probes, test leads, and accessories that have the same measurement category, voltage, and amperage ratings as the Product.

- **Connect the common test lead before the live test lead and remove the live test lead before the common test lead.**
- **Use only current probes, test leads, and adapters supplied with the Product.**
- **Do not touch the probes to a voltage source when the test leads are connected to the current terminals.**
- **Use only cables with correct voltage ratings.**
- **Do not use test leads if they are damaged. Examine the test leads for damaged insulation, exposed metal, or if the wear indicator shows. Check test lead continuity.**
- **Examine the case before you use the Product. Look for cracks or missing plastic. Carefully look at the insulation around the terminals.**
- **Always put the stackable end of the test lead into a terminal of the Product.**

Symbols used on the Product and in this manual are explained in Table 1.

Table 1. Symbols















Symbol	Meaning	Symbol	Meaning
	Earth ground		Common (LO) Input equipotentiality
	AC- alternating current		Conforms to relevant North American Safety Standards.
	DC- direct current		Conforms to European Union directives.
	Risk of danger. Important information. See manual.		Pressure
	Hazardous voltage. Risk of electrical shock.		This product complies with the WEEE Directive (2002/96/EC) marking requirements. The affixed label indicates that you must not discard this electrical/electronic product in domestic household waste. Product Category: With reference to the equipment types in the WEEE Directive Annex I, this product is classed as category 9 "Monitoring and Control Instrumentation" product. Do not dispose of this product as unsorted municipal waste. Go to Fluke's website for recycling information.

Table 1. Symbols (cont.)

Symbol	Meaning	Symbol	Meaning
	Application around and removal from HAZARDOUS LIVE conductors is permitted.		Conforms to relevant Australian standards.
	Double insulated		German certifying body.
CAT II	CAT II equipment is designed to protect against transients from energy-consuming equipment supplied from the fixed installation, such as TVs, PCs, portable tools, and other household appliances.		

Standard Equipment

Items included with the Product are listed below and shown in Figure 1. If the Product is damaged or something is missing, contact the place of purchase immediately.

- Battery with integrated charger/power supply and international adapters
- Printed multilingual *753/754 Getting Started Manual*
- *753/754 Manual CD* containing multilingual Users Manuals
- Three sets of TP220-1 test probes
- Three sets of 75X industrial test leads with stackable ends
- Three pairs of 754 Alligator Clip Set (extended tooth)
- Two sets of AC280 Suregrip Hook Clips (red and black)
- Adjustable quick-release strap
- Jumper for three-wire RTD measurement connections
- USB Cable: 6 ft. type A to type mini-B
- HART communications cable (754)
- Calibration Manual (available from Fluke's website)
- Sample *DPCTrack2* application software
- NIST-traceable Certificate of Calibration
- TC Input Cap

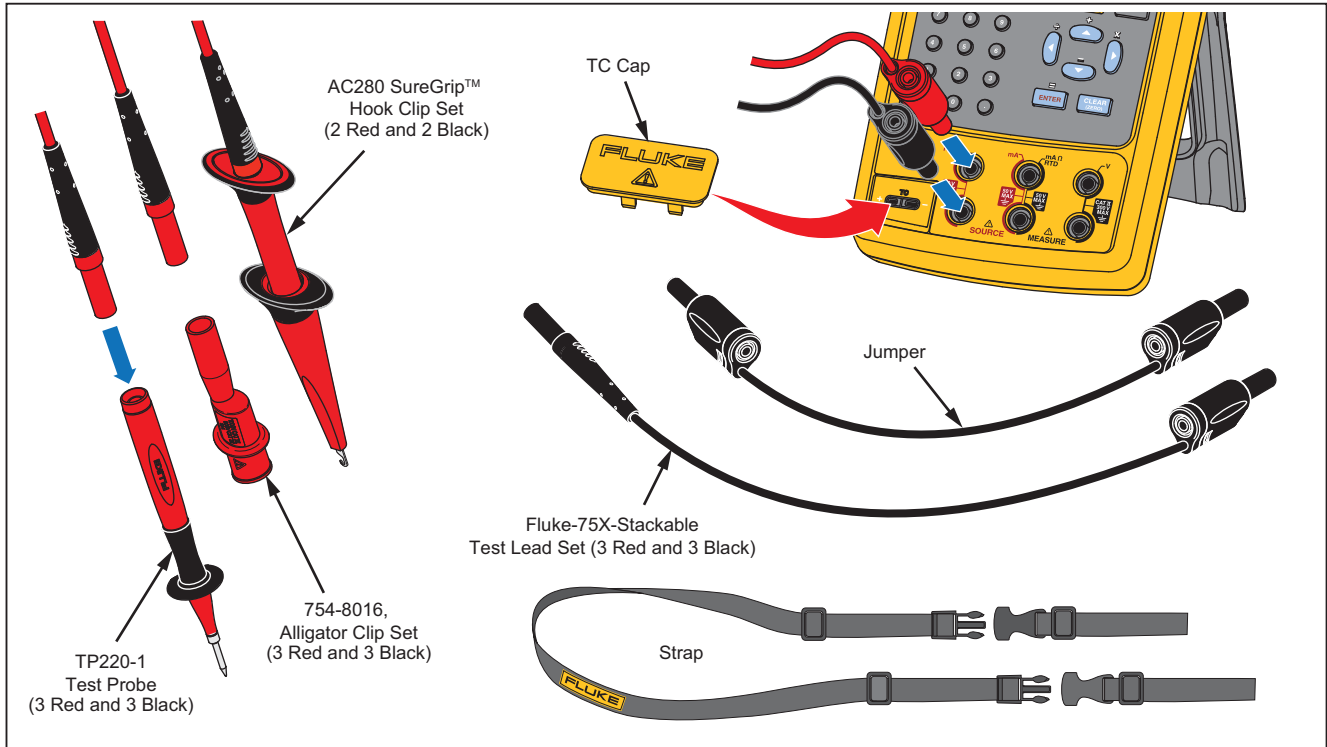

gks01f.eps

Figure 1. Standard Equipment

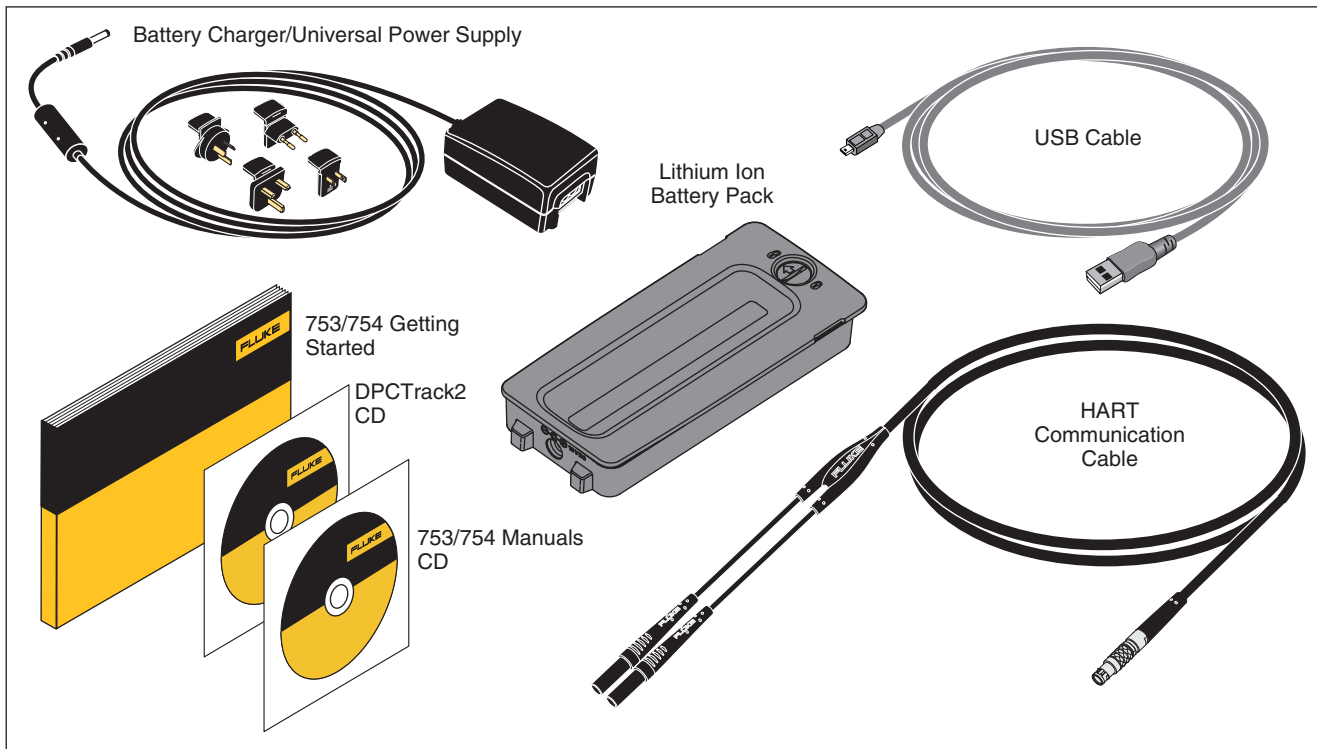

gks02f.eps

Figure 1. Standard Equipment (cont)











Functions

A summary of functions supplied by the Product is shown in Table 2. More features include:

- Analog display for easy to read measurements when inputs are unstable.
- Localized display (5 languages). See “Display Languages”.
- Thermocouple (TC) input/output jack and internal isothermal block with automatic reference-junction temperature compensation. Or manually record an external temperature reference.
- Test results storage.
- Data logging. Automatically log up to 8,000 data points.
- A USB computer interface to upload or download tasks, lists, and results.
- Automatic calibration procedures for transmitters and limit switches when you use split screen MEASURE/SOURCE mode.
- Transmitter mode in which the Product can be configured to emulate the functions of a process instrument.
- Calculator feature with square-root function, and accessible registers that contain measure and source values.
- Damp feature (smoothes the last several readings), with display indicator of damped status.
- Display of measurements in engineering units, percent of scale, square-law inputs, or custom units.
- Min/Max feature captures and shows minimum and maximum measured levels.
- Set source values to engineering units, percent of scale, square-law outputs, or custom units.
- Manual and automatic stepping and an output ramp feature for testing limit switches. Trip detect is either a 1 V change or a continuity status change (Open or Short) from one ramp increment to the next.

For performance testing and calibration instructions, download the *753/754 Calibration Manual* from Fluke’s website.

Table 2. Summary of Source and Measure Functions

Function	Measure	Source
 Volts dc	0 V to ± 300 V	0 V to ± 15 V (10 mA max)
 Volts ac	0.27 V to 300 V rms, 40 Hz to 500 Hz	No sourcing
 Frequency	1 Hz to 50 kHz	0.1 V to 30 V p-p sine wave, or 15 V peak square wave, 0.1 Hz to 50 kHz sine wave, 0.01 Hz square wave
 Resistance	0 Ω to 10 k Ω	0 Ω to 10 k Ω
 dc Current	0 mA to 100 mA	0 to 22 mA sourcing or sinking
 Continuity	Beep and the word Short indicates continuity	No sourcing
 Thermocouple	Types E, N, J, K, T, B, R, S, C, L,U, BP, or XK	
 RTD (2-W, 3-W, 4-W)	100 Ω Platinum (3926) 100 Ω Platinum (385) 120 Ω Nickel (672) 200 Ω Platinum (385) 500 Ω Platinum (385) 1000 Ω Platinum (385) 10 Ω Copper (427) 100 Ω Platinum (3916)	
 Pressure	^[1] 29 modules ranging from 0 to 1 inch H ₂ O (250 Pa) to 0 to 10,000 psi (69,000 kPa)	
 Loop Power	26 V	
[1] Use an external hand pump or other pressure source as a pressure stimulus for the source pressure function.		

Get Started

⚠⚠ Warning

To prevent possible electrical shock, fire, or personal injury:

- **Remove circuit power before you connect the Product in the circuit when you measure current. Connect the Product in series with the circuit.**
- **Do not touch exposed metal on banana plugs, they can have voltages that could cause death.**
- **Disconnect power and discharge all high-voltage capacitors before you measure resistance or continuity.**

A brief getting started exercise follows:

1. After you unpack the Product, charge the battery for 8 hours (if the battery is outside of the Product, charge for 5 hours). For more information, see “The Battery”. The Battery will only charge if the Product is off.
2. Connect voltage output to the voltage input. To do this connect the left pair of jacks (V Ω RTD SOURCE) to the right pair of jacks (V MEASURE). See Figure 2.
3. Push **⊕** to turn on the Product. If necessary, adjust the display brightness. See “Display Brightness”. The Product powers up in the dc voltage measurement function, and is reading on the V MEASURE pair of input jacks.
4. Push **MEASURE SOURCE** to show the SOURCE screen. The Product still measures dc voltage and the active measurement is at the top of the display.
5. Push **VDC** to select dc voltage sourcing. Push 5 on the keypad and **ENTER** to begin sourcing 5.0000 V dc.
6. Push **MEASURE SOURCE** to go to the split-screen, simultaneous MEASURE/SOURCE mode. The Product simultaneously sources dc volts and measures dc volts. The measurement readings are shown on the top display, and the active source value on the bottom display as shown in Figure 3.

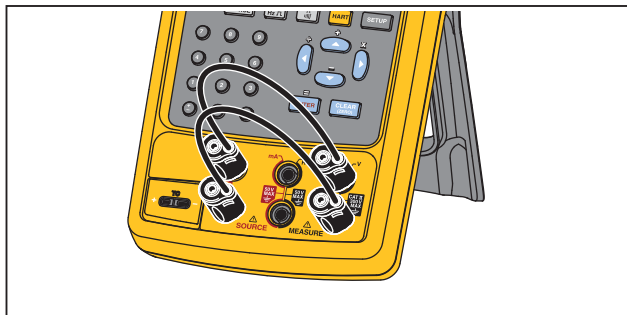

gks03f.eps

Figure 2. Jumper Connections

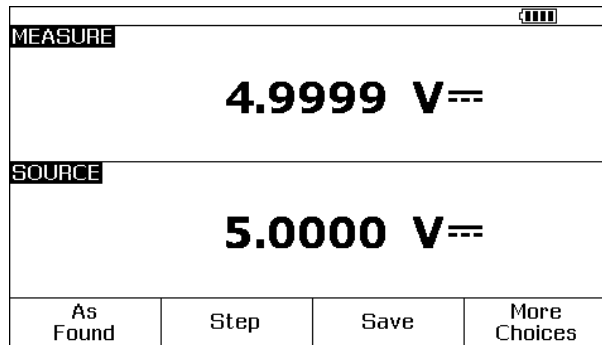

gks04s.bmp

Figure 3. Measure/Source Example

Operation Features

Input and Output Jacks

Figure 4 shows the input and output jacks and connectors.

Table 3 explains their use.

Table 3. Input/Output Jacks and Connectors

No.	Name	Description
①	HART jack (754 only)	Connects the Product to HART devices.
②	Pressure module connector	Connects the Product to a pressure module.
③	TC input/output	Jack to measure or simulate thermocouples. This jack accepts a miniature polarized thermocouple plug with flat, in-line blades spaced 7.9 mm (0.312 in) center to center.
④,⑤	⚠ MEASURE V jacks	Input jacks to measure voltage, frequency, or three- or four-wire RTDs (Resistance Temperature Detectors).
⑥,⑦	⚠ SOURCE mA, MEASURE mA Ω RTD jacks	Jacks to source or measure current, measure resistance and RTDs, and supply loop power.
⑧,⑨	⚠ SOURCE V Ω RTD jacks	Output jacks to source voltage, resistance, frequency, and to simulate RTDs.
⑩	Battery Charger jack	Jack for the battery charger/universal power supply (referred to as the battery charger throughout this manual). Use the battery charger for bench-top applications where ac line power is available.
⑪	USB port (Type 2)	Connects the Product to a USB port on a PC.

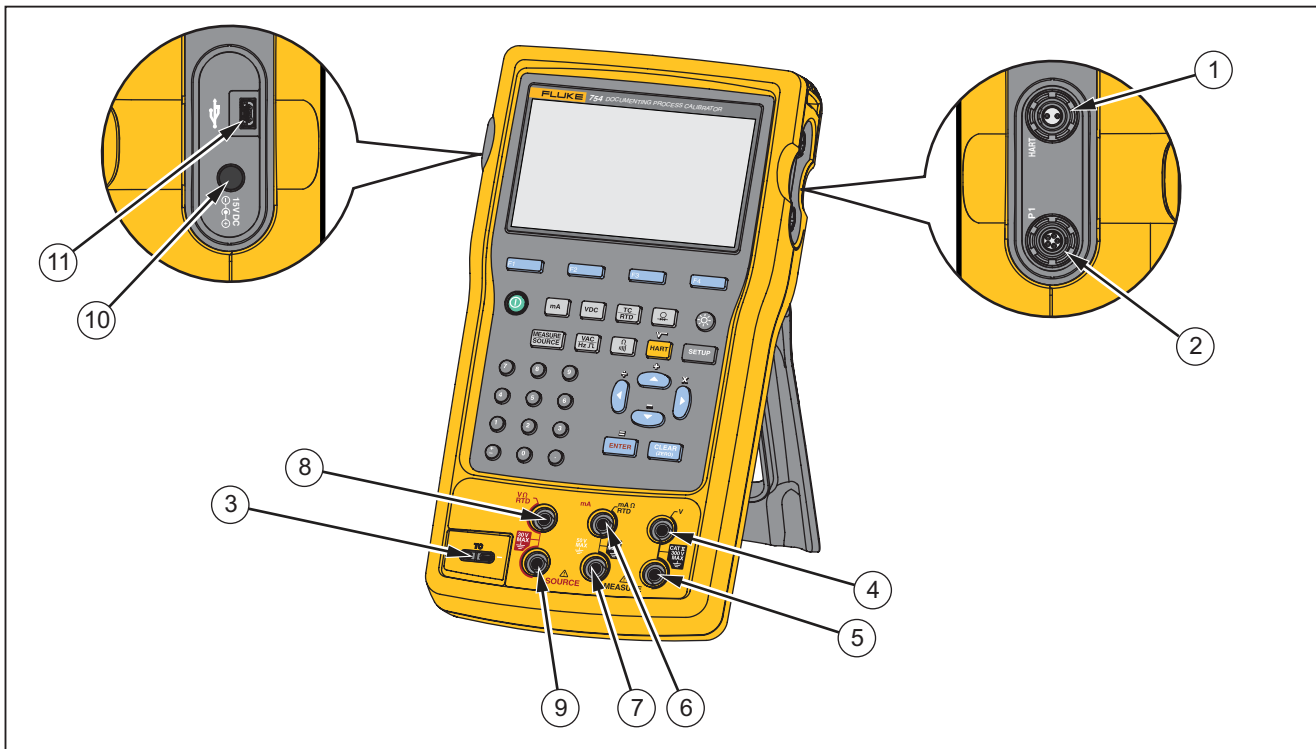

gks05f.eps

Figure 4. Input/Output Jacks and Connectors

Buttons

Figure 5 shows the Product buttons and Table 4 tells their functions. The softkeys are the four (F1-F4) blue buttons below the display. Softkey functions are defined by the labels that show above the softkey during operation. Softkey labels and other display text are shown in this manual in bold type, for example, **Choices**.

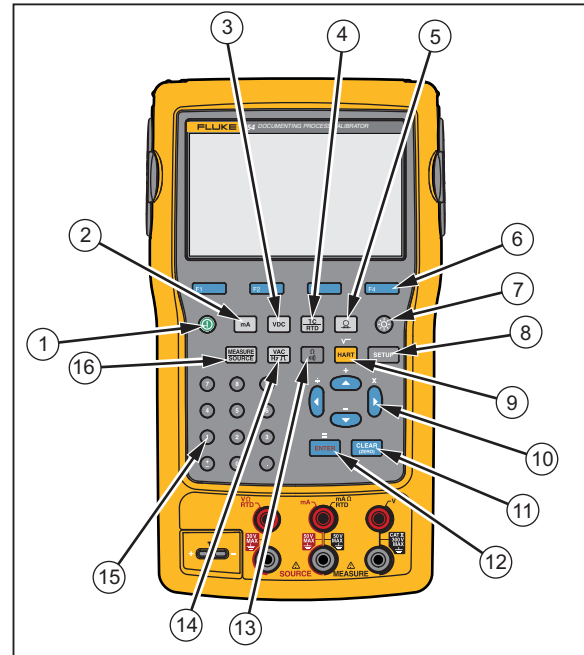

gks06f.eps

Figure 5. Buttons

Table 4. Buttons



















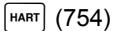
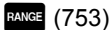

Item	Button	Description
①		Turns the Product on and off.
②		Selects mA (current) measure or source function. For loop power on/off, go to the Setup mode.
③		Selects the dc voltage function in MEASURE mode, or selects dc voltage in SOURCE mode.
④		Selects TC (thermocouple) or RTD (resistance temperature detector) measurement or sourcing functions.
⑤		Selects the pressure measurement or source function.
⑥	   	Softkeys. Does the function specified by the label above each softkey on the display.
⑦		Adjusts the backlight intensity (three levels).
⑧		Enters and exits Setup mode to change operating parameters.
⑨	 	(754) Toggles between HART communication mode and analog operation. In calculator mode, this key supplies the square root function. (753) Adjusts the Range of the Product.

Table 4. Buttons (cont)

Item	Button	Description
⑩		<p>Push  or  to increase display intensity. Push  or  to decrease intensity (seven levels). Make choices from lists on the display. Increase or decrease the source level when using the step feature. In calculator mode, provides arithmetic functions (+ - ÷ ×).</p>
⑪		<p>Clears a partial data entry, or prompts for output value when in the SOURCE mode. When you use a pressure module, zeros the pressure module indication.</p>
⑫		<p>Completes a numeric entry when a source value is set, or confirms a choice in a list. In calculator mode, acts as the equals arithmetic operator (=).</p>
⑬		<p>Toggles between resistance and continuity functions in MEASURE mode, or selects the resistance function in SOURCE mode.</p>
⑭		<p>Toggles between ac voltage and frequency functions in MEASURE mode, or selects frequency output in SOURCE mode.</p>
⑮	<p>Numeric keypad</p>	<p>Used when a numeric entry is necessary.</p>
⑯		<p>Cycles the Product through MEASURE, SOURCE, and MEASURE/SOURCE modes.</p>

Display

Figure 6 and Table 5 show a typical display. The display shown is MEASURE mode. Near the top of the display is “**Source Off**.” This display area shows what is happening in the other mode (SOURCE or MEASURE). The other parts of the display are:

- **Status Bar:** Shows the time and date, and the status of Loop Power, Auto Battery Save, and Backlight Timeout; all of which are set in Setup mode. The selected HART channel (if HART is active-754 only) and low-battery and backlight-on symbols are also show here.
- **Mode Indicator:** Shows if the Product is in MEASURE or SOURCE mode. In split screen MEASURE/SOURCE mode, there is a Mode Indicator for each window.
- **Measured Value:** Shows the measured value in a selection of engineering units or percent of scale.
- **Range Status:** Shows if Auto Range is on, and what range is currently in operation.
- **Custom Units Indicator:** Shows that the displayed units are custom. The initial engineering units of the measure or source function are not shown.
- **Secondary Value:** Shows the measure or source value in initial engineering units when scaling or custom units are on.

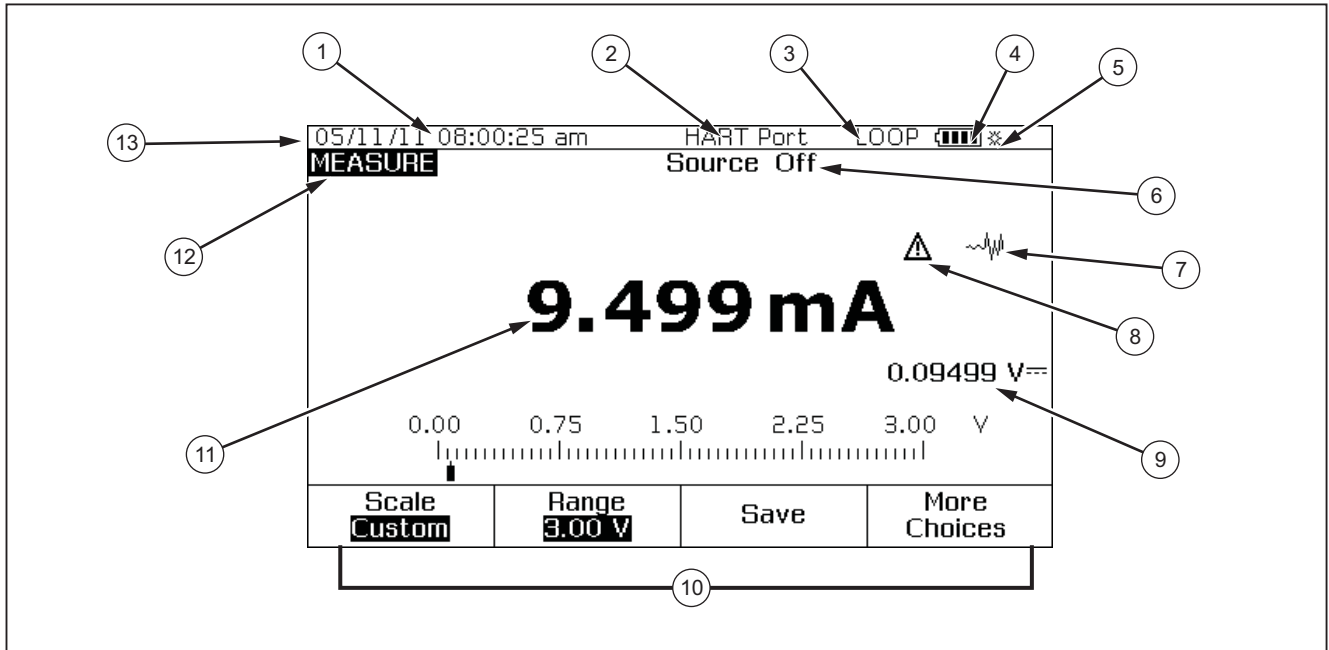

gks07c.eps

Figure 6. Elements of a Typical Display

Table 5. Elements of a Typical Display

Item	Description
①	Time and Date Display
②	HART Indicator
③	Loop Power Indicator
④	Battery Gauge
⑤	Backlight Indicator
⑥	Source Status
⑦	Undamped (Unsettled) Indicator
⑧	Custom Units Indicator
⑨	Secondary Value
⑩	Softkey Labels
⑪	Measured Value
⑫	Mode Indicator
⑬	Status bar

Strap and Stand

After you unpack the Product, attach its carrying strap as shown in Figure 7. The straps can be adjusted as necessary to hang the Product on any sturdy support. Figure 7 also shows how to open the Stand to put the Product at an optimal sight angle for bench top use.

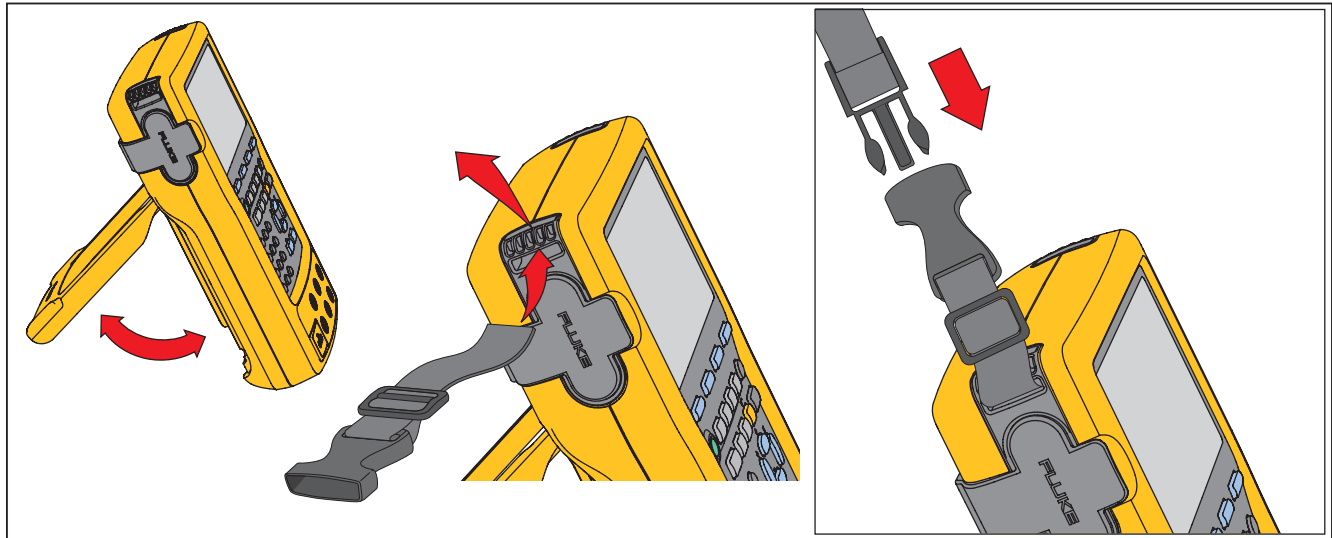

Figure 7. Stand Use and Strap Attachment

gks8f.eps

The Battery

⚠ Caution

For safe operation and maintenance of the product:

- Do not keep cells or batteries in a container where the terminals can be shorted.
- Repair the Product before use if the battery leaks.
- Remove battery to prevent battery leakage and damage to the Product if it is not used for an extended period.
- Connect the battery charger to the mains power outlet before the Product.
- Use only Fluke approved power adapters to charge the battery.
- Keep cells and battery packs clean and dry. Clean dirty connectors with a dry, clean cloth.
- Do not short the battery terminals together.

⚠ Warning

To prevent personal injury:

- Do not put battery cells and battery packs near heat or fire. Do not put in sunlight.
- Do not disassemble or crush battery cells and battery packs.
- Do not disassemble the battery.
- Batteries contain hazardous chemicals that can cause burns or explode. If exposure to chemicals occurs, clean with water and get medical aid.

Charge the Battery



Before you use the Product for the first time, charge its battery.

To charge the battery while it is inside the Product:

1. Turn the Product OFF.
2. Connect the battery charger to the Product and keep it OFF. The battery will not charge if the Product is on.

The battery fully charges in 8 hours while inside the Product. See Figure 8.

To charge the battery while it is outside of the Product:

1. Turn the Product face down.
2. Use a flat-head screwdriver and move the battery lock from  (locked) to  (unlocked).

3. Remove the battery.
4. Connect the battery charger to the input. Outside of the Product, the battery will charge in 5 hours.

Note

An optional 12-Volt car charger is available. See "Accessories".

Battery Charge Level

Use these two methods to make sure the Battery is charged:

- See the Battery Gauge Bar Graph on the display.
- See the Battery Charge Indicator on the battery.

The Battery Charge Indicator can be seen while the battery is outside of the Product. With the battery removed and not connected to its charger, push the button below the Battery Charge Indicator. Solid Green LEDs show the level of charge on the battery. The Battery is fully charged when all LEDs are illuminated.

Connect the battery charger to the battery and push the button below the Battery Charge Indicator. LEDs flash to show the charge level but also show that the battery is being recharged. As the battery charges, the LED flashes and moves to the top of the charge indicator.

Battery Life



The battery gauge bar graph  is shown on the upper right of the display.

Table 6 shows the typical operation time for a new, fully-charged battery. Product performance is guaranteed to its specification until the battery gage reads empty ().

To replace the battery, see "Battery Replacement".

Table 6. Typical Battery Life

Operation Modes	Backlight Low	Backlight High
Measure, continuous	13 Hours	12 Hours
Measure and source, with loop power on, continuous	7 Hours	6 Hours
Typical intermittent operation	>16 Hours	>16 Hours

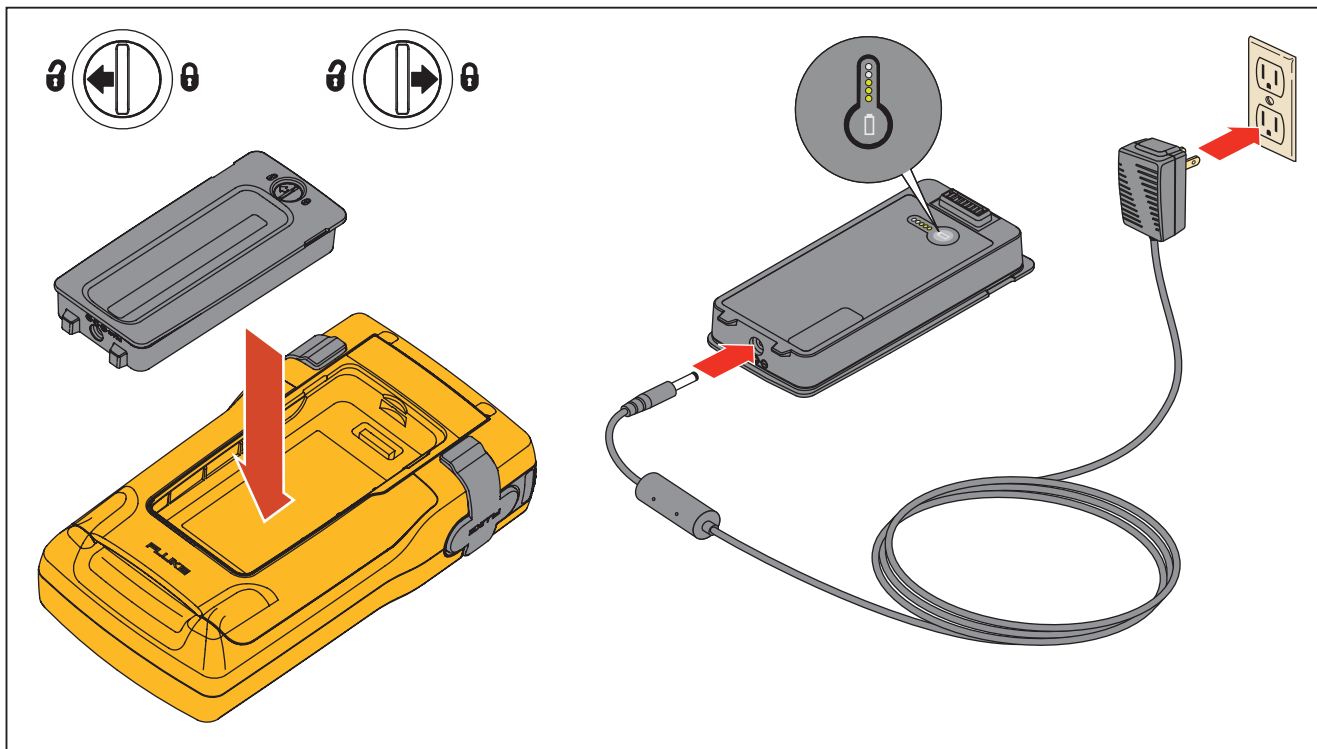







gks9f.eps

Figure 8. Battery Removal and Charger Use

Preserve Battery Life

An optional Auto Battery Save feature turns the Product off after a selected set idle time. The default setting for Auto Battery Save is **Off**. The setting is kept after the Product power is off. Auto Battery Save operates the same when the battery charger is used.

To turn on the Auto Battery Save feature:

1. Push **SETUP**.
2. Push  to highlight **Off** that follows **Auto Battery Save**.
3. Push  or the **Choices** softkey.
4. Push  to highlight **On**, then push .
5. To use the timeout period shown on the display, stop here. Push the **Done** softkey to exit Setup mode and do not go on to step 6.
6. If you wish to change the timeout period, push  to select the timeout period following **Battery Save Timeout**.
7. Push  or the **Choices** softkey.
8. Record choice of timeout period in minutes (accepted range: 1 to 120 minutes).
9. Push the **Done** softkey.
10. Push the **Done** softkey or **SETUP** to exit Setup mode.

The Battery Charger

Caution

To avoid damage to the Product, use only the Battery that comes with the Product, Fluke model BP7240, part number 4022220.

Where ac power is available, the battery charger can be used to conserve battery power and energize the Product. When the battery is in the Product, the battery charges only when the Product is off. When you calibrate an instrument, best results come from battery power use.

An optional 12-V car adapter is available that can be used to charge the battery outside of the Product. See “Accessories”.

Display Languages

The Product shows information in five languages:

- English
- European French
- Italian
- German
- Spanish

To change the display language:

1. Push **SETUP**.
2. Push **F3** twice.
3. Push **▼** three times.
4. Push **ENTER**.
5. Push **▲** or **▼** to highlight the language choice.
6. Push **ENTER** to confirm the language choice. This language is the power-up default.
7. Push **SETUP** to exit Setup mode.

Display Intensity

There are two ways to increase display intensity:

- Push **⊗**. There are three levels of intensity when using this button.
- Push **▲** or **▶** to increase display intensity. Push **▼** or **◀** to decrease intensity. There are six levels of intensity when these buttons are used.

In calculator mode, all four direction keys are used for arithmetic functions.

Date and Time

The date and time can be shown at the top of the display during normal operation. The date and time can be turned on or off in Setup mode. Date and time formats can also be controlled. If you choose to not use the date and time display, the calendar and clock must be set since a timestamp is applied to all kept results.

To set the time and date displays:

1. Push **SETUP**.
2. Push the **Next Page** softkey. See Figure 9.

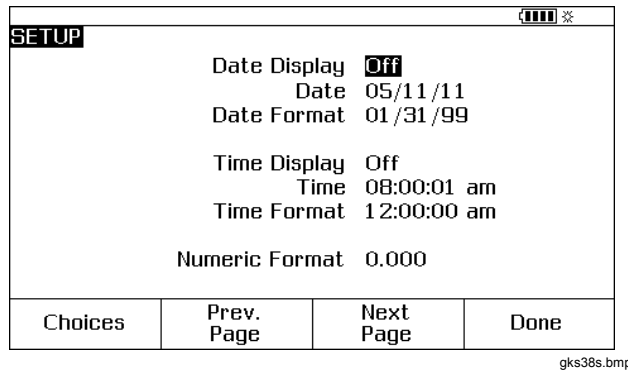

Figure 9. Time and Date Display

3. Push **▲** and **▼** to move the cursor to the necessary parameter, then push **ENTER** or the **Choices** softkey to choose a setting for that parameter.

For example, the display in Figure 10 is shown after you select **Date Format**.

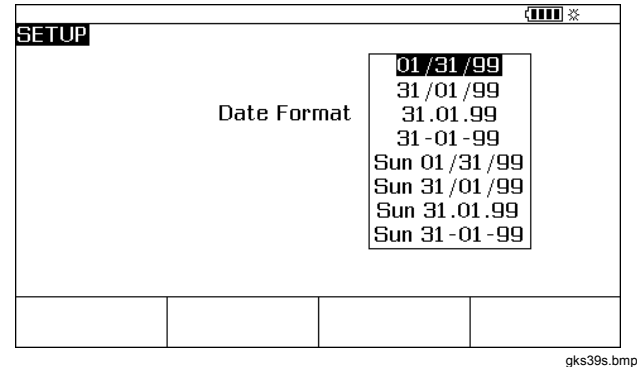













Figure 10. Edit the Date Format

4. Push **▲** or **▼** to move the cursor to the necessary date format.
5. Push **ENTER** to select the format and go back to Setup mode.
6. Choose a different selection or push the **Done** softkey or **SETUP** to save the settings and exit Setup mode.

The Backlight

Push  to change the backlight intensity from dim to bright and back again.  shows at the top of the display when the backlight is active. Set the Product to turn the backlight off automatically to keep battery use to minimum. When the backlight is on and Auto Backlight Off is in operation,  is shown at the top of the display.



To automatically dim the backlight after a set time:

1. Push .
2. Push  to move the cursor to the same line as **Auto Backlight Off**.
3. Push  or the **Choices** softkey.
4. Push  to highlight **On**, then push .
5. To use the timeout period shown on the display, stop here. Push the **Done** softkey to exit Setup mode and do not go on to step 6.
6. To change the timeout period, push  to highlight the timeout period following **Backlight Timeout**.
7. Push  or the **Choices** softkey.
8. Record the choice of timeout period in minutes (accepted range: 1 to 120 minutes).
9. Push the **Done** softkey.
10. Push the **Done** softkey or  to exit Setup mode.

When the backlight dims, the Product also beeps.

Personalize the Product





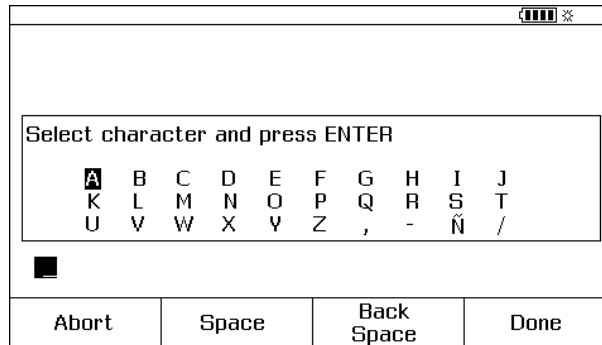

Alphanumeric identifiers can be put into the Product to be shown at power-up and in results that you keep. To install an identifier:

1. Push .
2. Push **Next Page** twice.
3. Push  to move the cursor to the same line as **ID**.
4. Push  or the **Choices** softkey. The screen in Figure 11 is shown.



gks40s.bmp

Figure 11. Personalize the Product

- The **ID** string is shown at the bottom of the boxed area. To erase a character, push the **Back Space** softkey. To erase the complete string, push . Information recorded in the ID string is recorded with all measurements stored in memory.
- Push , , , or  to select a character, then push . Use the numeric keypad to record numbers.
- Do step 6 until satisfied with the ID string.
- Push the **Done** softkey.
- Push the **Done** softkey or  to exit Setup mode.

Measure Mode

Note

To get the best noise rejection and highest accuracy performance when you measure, use the battery; do not use the battery charger.

The operation mode (for example, MEASURE, SOURCE) is shown in the top left of the display. If the Product is not in MEASURE mode, push  until MEASURE is shown. The Product must be in MEASURE mode to change the MEASURE parameters.





Measurement Ranges

The Product usually changes to the correct measurement range automatically. The lower left side of the display shows “Range” or “Auto” if on the range status. Auto Range switch points are shown in Specifications. When the **Range** softkey is pushed, the range is locked. Push it again to go to and lock on the next higher range. Auto Range is in operation when a different measurement function is selected.

If the range is locked, overrange inputs show on the display as - - - - -. In Auto Range, out of range is shown as ! ! ! ! !.

Electrical Parameter Measurement

When the Product is turned on, it is in the dc voltage measurement function. Figure 12 shows electrical measurement connections. To select an electrical measurement function from SOURCE or MEASURE/SOURCE mode, first push  for MEASURE mode:

1. Push  for current,  for dc voltage,  once for ac voltage or twice for frequency, or  for resistance.

Note

When you measure frequency, the Product tells you to select a frequency range. If the measured frequency is expected to be below 20 Hz, push  to select the lower frequency range, and then push

.

2. Connect the test leads for your measurement function as shown in Figure 12.

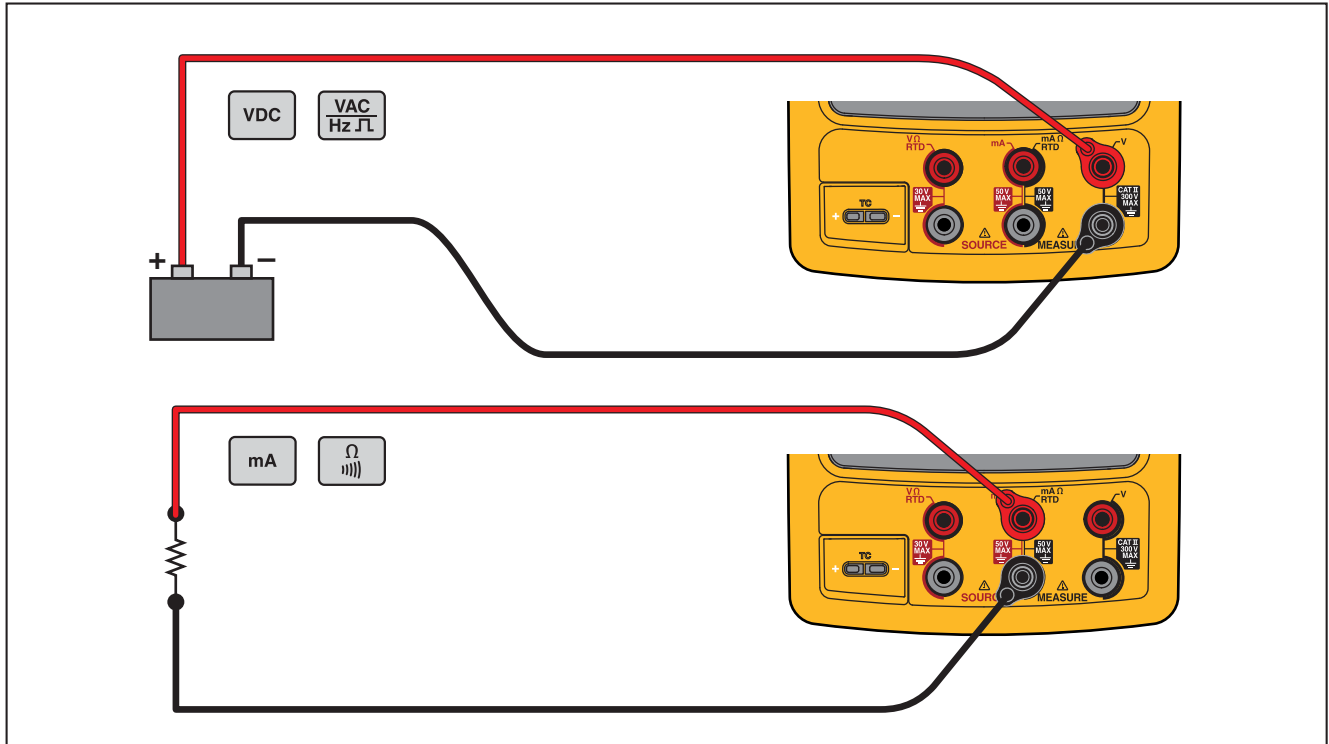



gks10f.eps

Figure 12. Electrical Measurement Connections

Continuity Test

When you do a continuity test, the beeper sounds and **Short** is shown on the display when the resistance between the Ω MEASURE jack and its common jack is less than 25 Ω . **Open** is shown when the resistance is larger than 400 Ω .

To do a continuity test:

1. De-energize the circuit under test.
2. If necessary, push  for MEASURE mode.
3. Push  twice so that **Open** is shown.
4. Connect the Product to the circuit under test. See Figure 12.

Pressure Measurement

Many ranges and types of pressure modules are available from Fluke. See “Accessories”. Before you use a pressure module, read its instruction sheet. The modules are different in how they are used, zeroed, what types of process pressure media are allowed, and accuracy specifications.

Figure 13 shows gage and differential modules. Differential modules also operate in gage mode when you leave the low fitting open to atmosphere.

To measure pressure, attach the applicable pressure module for the process pressure you will test as described in the module’s Instruction Sheet.

To measure pressure:

Warning

To prevent personal injury, shut off the valve and slowly bleed off the pressure before attaching the pressure module to the pressure line to avoid a violent release of pressure in a pressurized system.

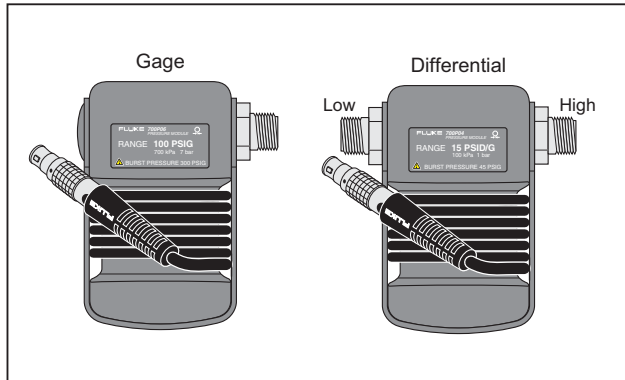

gks11f.eps



Figure 13. Gage and Differential Pressure Modules

⚠ Caution

To prevent possible damage to the Product or to equipment under test:





- Never apply more than 10 ft.-lb. of torque between the pressure module fittings, or between the fittings and the body of the module.
- Always apply correct torque between the pressure module fitting and connecting fittings or adapters.
- Never apply pressure above the rated maximum printed on the pressure module.
- Use the pressure module only with specified materials. See the printing on the pressure module or the pressure module instruction sheet for the acceptable material compatibility.

Connect a pressure module to the Product as shown in Figure 14. The threads on the pressure modules accept standard ¼ NPT pipe fittings. Use the supplied ¼ NPT to ¼ ISO adapter if necessary.

1. Push  for MEASURE mode.
2. Push . The Product automatically senses which pressure module is attached and sets its range accordingly.
3. Zero the pressure. See the module's Instruction Sheet. Modules can have different zeroing procedures that depend on module type.

Note

Zeroing MUST be done before doing a task that sources or measures pressure.

4. If necessary, the pressure display units can be changed to psi, mHg, inHg, inH₂O, ftH₂O, mH₂O, bar, Pa, g/cm², or inH₂O@60°F. Metric units (kPa, mmHg, etc.) are shown in Setup mode in their base units (Pa, mHg, etc.). To change pressure display units:
 1. Push .
 2. Push **Next Page** twice.
 3. Push  or the **Choices** softkey with the cursor on **Pressure Units**.
 4. Set the pressure units with  or .
 5. Push .
 6. Push the **Done** softkey.

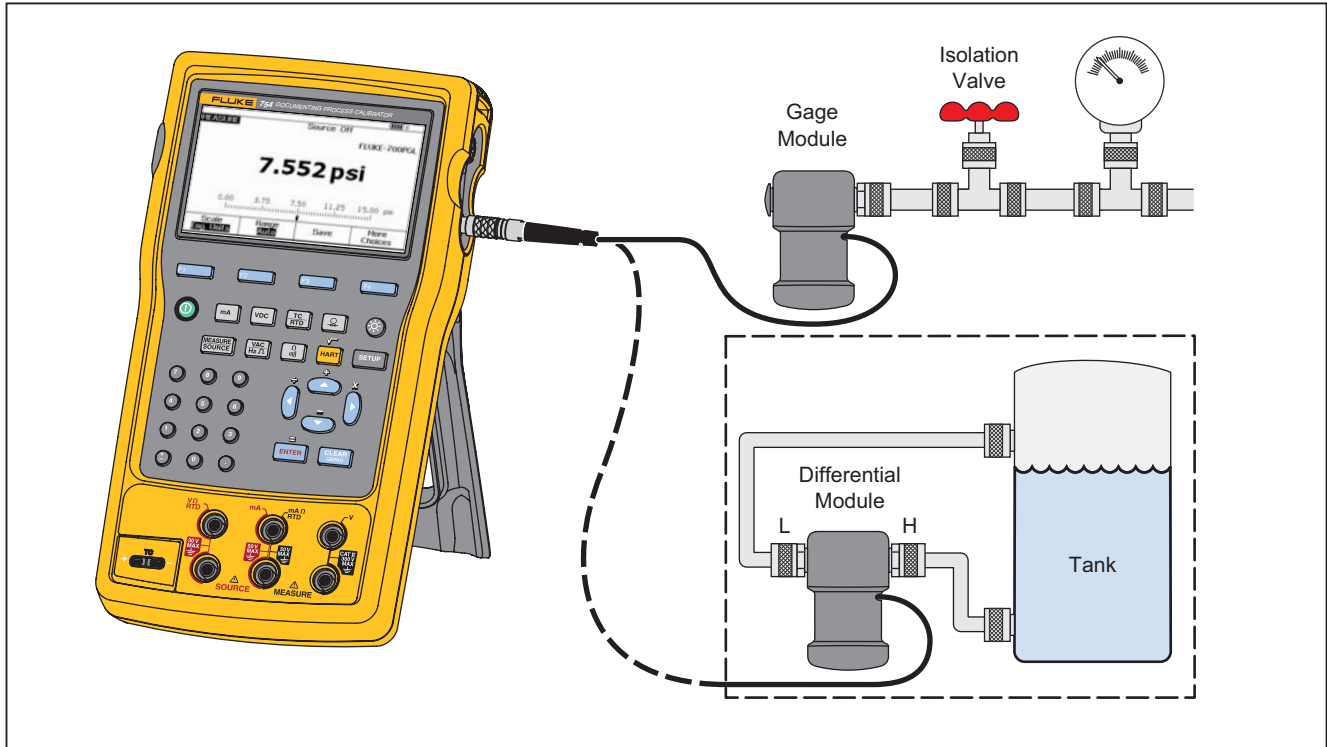

gks12c.eps

Figure 14. Pressure Measurement Connections

Temperature Measurement

Thermocouple Use

The Product supports thirteen standard thermocouples, each identified with an alpha character: E, N, J, K, T, B, R, S, C, L, U, XK, or BP. Table 7 summarizes the ranges and qualities of the supported thermocouples.

To measure temperature using a thermocouple:





1. Attach the thermocouple leads to the correct TC miniplug, then to the TC input/output. See Figure 15.

Caution

To prevent possible damage to the Product, do not try to force a miniplug in the wrong polarization. One pin is wider than the other.

Note

If the Product and the thermocouple plug are at different temperatures, stop for one minute or more for the connector temperature to stabilize after you plug the miniplug into the TC input/output.

2. If necessary, push  for MEASURE mode.
3. Push .
4. Select **TC**.
5. The display tells you to select the thermocouple type.
6. Select the necessary thermocouple type using the  or  followed by .









7. If necessary, change between °C, °F, °R, and °K **Temperature Units** as follows:
 1. Push .
 2. Push the **Next Page** softkey twice.
 3. Push  and  to move the cursor to the necessary parameter.
 4. Push  or the **Choices** softkey to choose a setting for that parameter.
 5. Push  or  to move the cursor to the necessary setting.
 6. Push  to go back to the  display.
 7. Push the **Done** softkey or  to exit Setup mode.
8. If necessary, change between **ITS-90** or **IPTS-68 Temperature Scale** in Setup mode. The procedure is the same as steps 1-7 above.

Table 7. Thermocouple Types Accepted

Type	Positive Lead Material	Positive Lead (H) Color		Negative Lead Material	Specified Range (°C)
		ANSI ^[1]	IEC ^[2]		
E	Chromel	Purple	Violet	Constantan	-250 to 1000
N	Ni-Cr-Si	Orange	Pink	Ni-Si-Mg	-200 to 1300
J	Iron	White	Black	Constantan	-210 to 1200
K	Chromel	Yellow	Green	Alumel	-270 to 1372
T	Copper	Blue	Brown	Constantan	-250 to 400
B	Platinum (30 % Rhodium)	Gray		Platinum (6 % Rhodium)	600 to 1820
R	Platinum (13 % Rhodium)	Black	Orange	Platinum	-20 to 1767
S	Platinum (10 % Rhodium)	Black	Orange	Platinum	-20 to 1767
C ^[3]	Tungsten (5 % Rhenium)	White		Tungsten (26 % Rhenium)	0 to 2316
L (DIN J)	Iron			Constantan	-200 to 900
U (DIN T)	Copper			Constantan	-200 to 600
BP	95 % W + 5 % Re	GOST		80 % W + 20 % Re	0 to 2500
		Red or Pink			
XK	90.5 % Ni = 9.5 % Cr	Violet or Black		56 % CU + 44 % Ni	-200 to 800
<p>[1] American National Standards Institute (ANSI) device negative lead (L) is always red. [2] International Electrotechnical Commission (IEC) device negative lead (L) is always white. [3] Not an ANSI designation but a Hoskins Engineering Company designation.</p>					

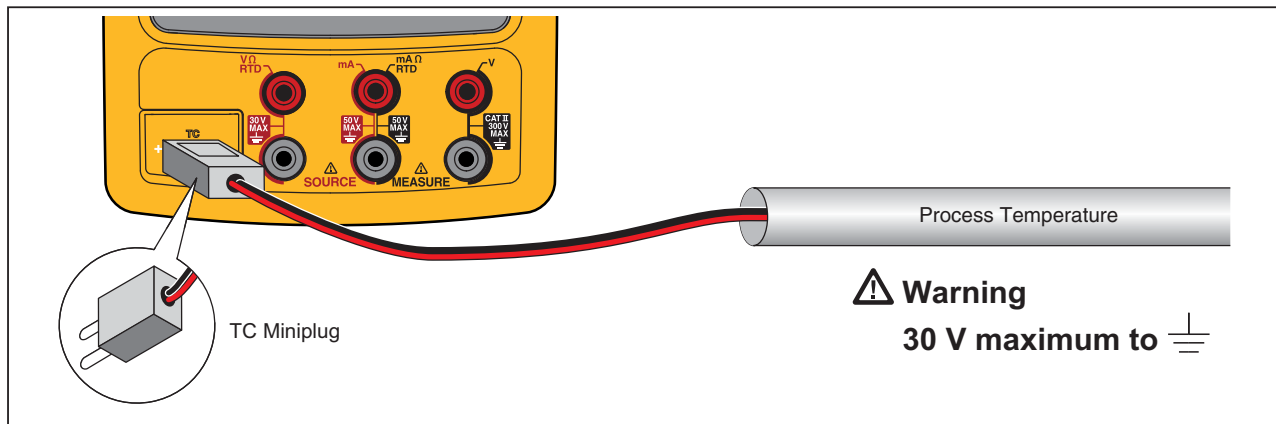

gks12f.eps

Figure 15. Temperature Measurement with a Thermocouple











Resistance-Temperature Detectors (RTDs)

The Product accepts RTD types shown in Table 8. RTDs are characterized by their resistance at 0 °C (32 °F), which is called the “ice point” or R_0 . The most common R_0 is 100 Ω . A large number of RTDs come in a three-terminal configuration. The Product accepts RTD measurement inputs in two-, three-, or four-wire connections. See Figure 17. A four-wire configuration gives the highest measurement precision, and two-wire gives the lowest measurement precision.

Table 8. RTD Types Accepted

RTD Type	Ice Point (R_0)	Material	α	Range (°C)
Pt100 (3926)	100 Ω	Platinum	0.003926 $\Omega/\Omega/^\circ\text{C}$	-200 to 630
Pt100 (385) ^[1]	100 Ω	Platinum	0.00385 $\Omega/\Omega/^\circ\text{C}$	-200 to 800
Ni120 (672)	120 Ω	Nickel	0.00672 $\Omega/\Omega/^\circ\text{C}$	-80 to 260
Pt200 (385)	200 Ω	Platinum	0.00385 $\Omega/\Omega/^\circ\text{C}$	-200 to 630
Pt500 (385)	500 Ω	Platinum	0.00385 $\Omega/\Omega/^\circ\text{C}$	-200 to 630
Pt1000 (385)	1000 Ω	Platinum	0.00385 $\Omega/\Omega/^\circ\text{C}$	-200 to 630
Cu10 (427)	9.035 Ω ^[2]	Copper	0.00427 $\Omega/\Omega/^\circ\text{C}$	-100 to 260
Pt100 (3916)	100 Ω	Platinum	0.003916 $\Omega/\Omega/^\circ\text{C}$	-200 to 630
[1] Per IEC 751-Standard				
[2] 10 Ω @ 25 °C				

To measure temperature where an RTD input is used:

1. If necessary, push  for MEASURE mode.
2. Push .
3. Push  and  then **Select RTD Type** is shown.
4. Push  or  to select the necessary RTD type.
5. Push .
6. Push  or  to select a 2-, 3-, or 4-wire connection. The connections are shown on the display.
7. Attach the RTD to input jacks as the display or Figure 14 shows. Use the supplied jumper between the mA Ω RTD MEASURE low jack and the V MEASURE low jack as shown if using a 3-wire connection.
8. Push .

 **Caution**

To prevent possible damage to the Product, do not force a dual banana plug between any two jacks in the horizontal orientation. Doing so will damage the jacks. Use the supplied jumper wire when needed for RTD measurements. A dual banana plug may be used in the vertical orientation. See Figure 16.

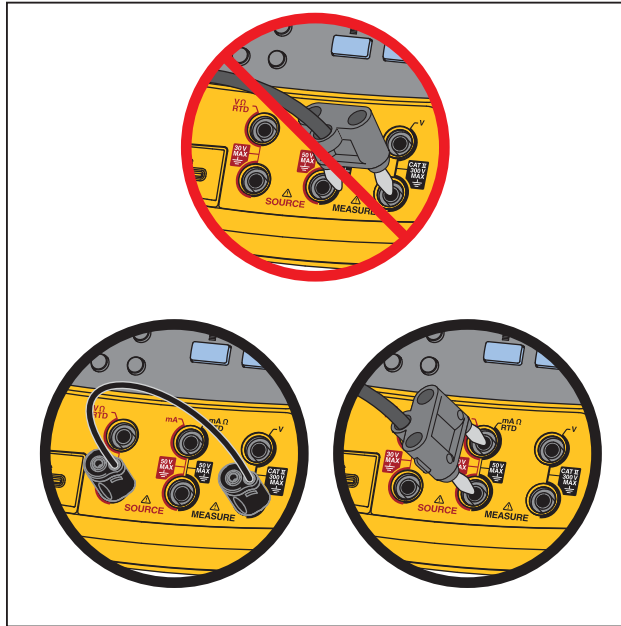

gks14f.eps

Figure 16. Correct Jumper Use

8. If necessary, change between °C, °F, K, and °R temperature units in Setup:
 1. Push **SETUP**.
 2. Push the **Next Page** softkey twice.
 3. Push **▲** and **▼** to move the cursor to **Temperature Units**.
 4. Push **ENTER** or the **Choices** softkey to choose a setting for that parameter.
 5. Push **▲** or **▼** to move the cursor to the necessary setting.
 6. Push **ENTER** to go back to the **SETUP** display.
 7. Push the **Done** softkey or **SETUP** to exit Setup mode.
9. If necessary, change between **ITS-90** or **IPTS-68 Temperature Scale** in Setup mode. The procedure is the same as steps 1-7 above.

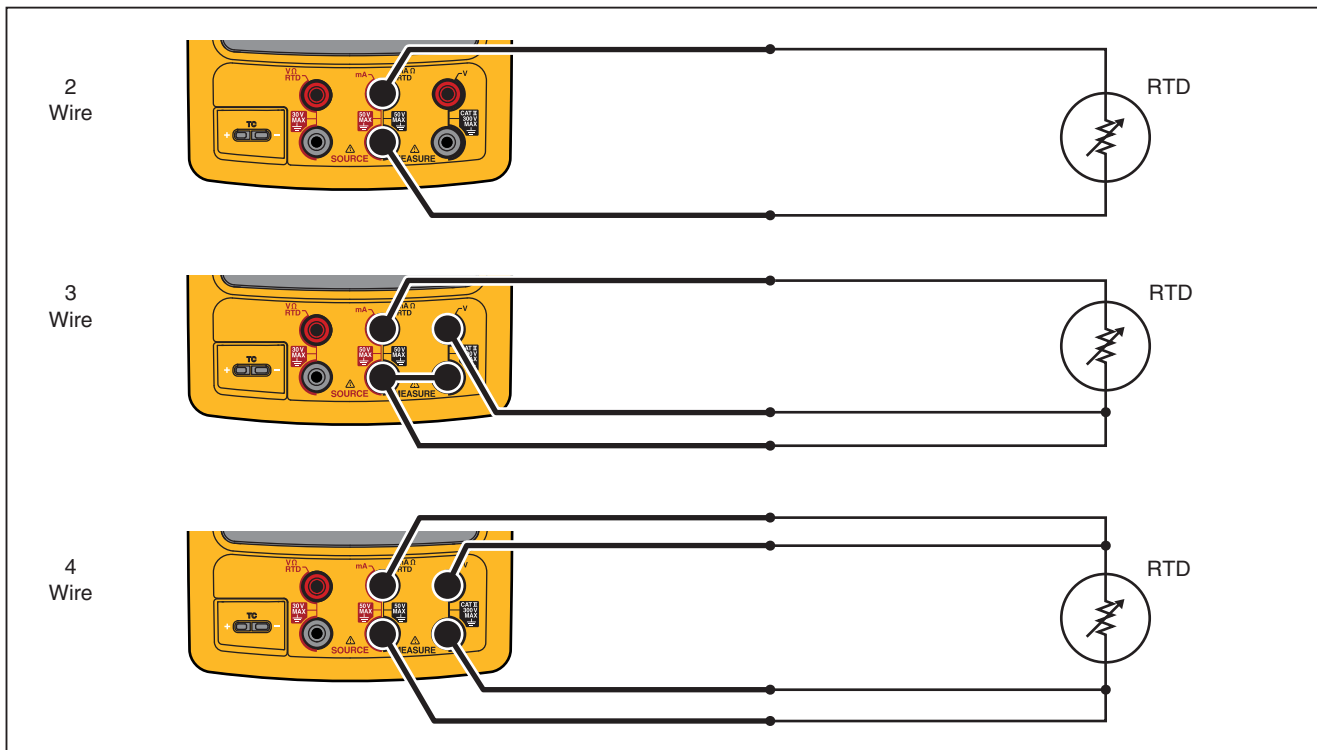









gks15f.eps

Figure 17. Temperature Measurement with an RTD

Measurement Scale

This feature scales measurements in accordance with a applicable process instrument's response. Percent of scale works for linear-output transmitters or square-law transmitters such as differential pressure transmitters that report flow rate.









Linear-Output Transmitters

1. If necessary, push  for MEASURE mode.
2. Select a measurement function (, , , , , or ) as previously described.
3. Push the **Scale** softkey.
4. Select % from the list.
5. Use the numeric keypad to record the 0% of scale value (**0% Value**).
6. Push .
7. Use the numeric keypad to record the 100% of scale value (**100% Value**).
8. Push .
9. Push the **Done** softkey.

Percent of scale stays in effect until you change to a different measurement function or until you push the **Scale** softkey and select a different scale mode.

Square-Law Process Variables

When you select $\sqrt{\quad}$ within scaling, the Product takes the square root of its input and shows the measurement in percent. For example, when the Product is connected to the output of a delta-pressure transmitter, the Product indication is in proportion to flow rate.

1. If necessary, push  for MEASURE mode.
2. Select a measurement function (, , , , , or ) as previously described.
3. Push the **Scale** softkey.
4. Select $\sqrt{\quad}$ from the list.
5. Use the numeric keypad to record the 0% of scale value (**0% Value**).
6. Push .
7. Use the numeric keypad to record the 100% of scale value (**100% Value**).
8. Push the **Done** softkey.

Square root percent of scale stays in effect until you change to a different measurement function or the **Scale** softkey is pushed and you select a different scale mode.

Measure or Source with Custom Units

⚠⚠ Warning

To avoid possible electric shock, when using Custom Units for measurement, always see the secondary value displayed below and to the right of the main display for the actual value of the measurement in native engineering units.

The measurement or source display can be setup to show custom units. To do this, select a function, for example mV dc, scale it as necessary, then record an alphanumeric name for the custom units, for example, "PH."

To set up a custom unit:

1. When you measure or source the necessary function, push the **Scale** softkey, and then select **Custom Units** from the list.
2. Record the 0% and 100% scale points for the input of the transfer function.
3. Push the **Custom Units** softkey.
4. Record the 0% and 100% scale points for the output of the transfer function.
5. Record the name of the custom units (up to four characters), for example **PH** (for pH), using the alphanumeric entry window, then push .

While **Custom Units** are active, Δ shows on the display to the right of the custom unit. Once the custom measurement unit has been programmed, the unit is available for calibration procedures in split-screen MEASURE/SOURCE mode. To cancel **Custom Units**, push the **Custom Units** softkey again.

Using the 700-IV Current Shunt

To source and measure current simultaneously, a current shunt is necessary and uses the volts measure function. The Fluke 700-IV Current Shunt is designed specifically for use with the 700 Series Documenting Process Products.

To measure current with the current shunt:

1. Connect the current shunt to the MEASURE V jacks.
2. Connect the current signal to be measured to the current shunt.
3. Push to select the dc voltage measure function.
4. Push the **Scale** softkey.
5. Select **Current Shunt** from the list.
6. Push .
7. The Product is automatically configured and uses the correct custom scaling factor for the current shunt.

Damping Measurements

The Product normally applies a software filter to dampen measurements in all functions except continuity. The specifications assume that damping is turned on. The damping method is a running average of the last eight measurements. Fluke recommends leaving damping on. Turning damping off may be useful when measurement response is more important than accuracy or noise reduction. To turn damping off, push the **More Choices** softkey twice, then push the **Dampen** softkey so that **Off** is shown. Push **Dampen** again to turn damping back on. The default state is **On**.

Note











If a measurement falls outside a random noise window, a new average is started. If damping is turned off, or until measurements are fully damped, the  symbol is displayed.

Source Mode

The operating mode (for example, MEASURE, SOURCE) is shown on the display. If the Product is not in SOURCE mode, push  until SOURCE is shown. The Product must be in SOURCE mode to change any of the SOURCE parameters.

Source Electrical Parameters

To select an electrical source function:

1. Connect the test leads as shown in Figure 18, depending on the source function.
2. Push  for current,  for dc voltage,  for frequency, or  for resistance.
3. Record the necessary output value, then push . For example, to source 5.5 V dc, push     .

Note

If sourcing frequency, respond when the Product asks you to select a zero-symmetric sine or positive square wave. The amplitude specified is p-p amplitude.

4. To change the output value, record a new value and push .

Note

If sourcing current, wait for the  symbol to disappear before you use the output.

5. To set the output value in the present source function, push then enter the desired value and push .
6. To turn off sourcing completely, push twice.

Note

*Use the source current function to drive a current loop. This is different than the loop power function in which the Product is powering a process instrument. To source loop power, use the **Loop Power** function accessible from Setup mode.*

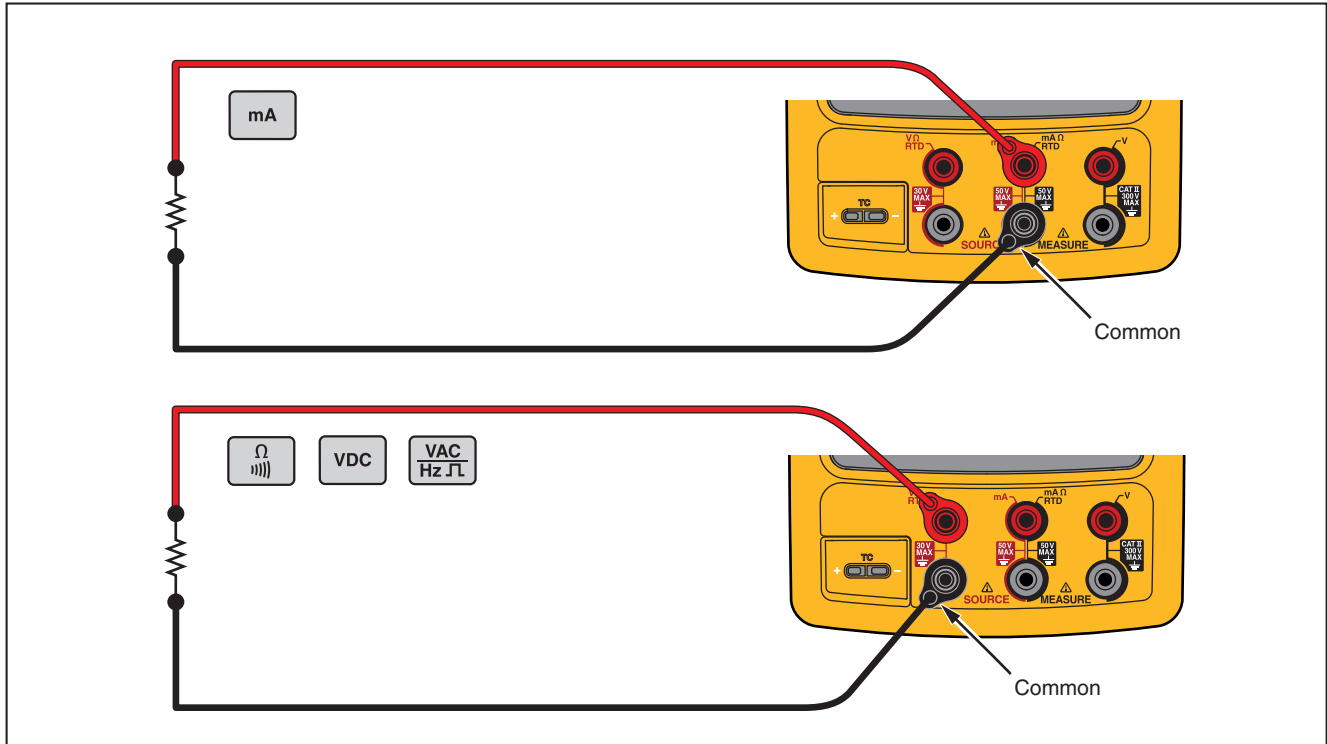

gks16f.eps

Figure 18. Electrical Source Connections

4 to 20 mA Transmitter Simulation

The Product can be configured as a load on a current loop through the SOURCE mA function. In SOURCE mode, when  is pressed, the display prompts to select **Source mA** or **Simulate Transmitter**. When you **Source mA** the Product is sourcing current, and when you **Simulate Transmitter** the Product is sourcing a variable resistance to keep the current to the specified value. Connect an external loop supply to the positive (top) mA jack as shown in Figure 19.

Note

Also see “Transmitter Mode” in which the Product can be temporarily configured to replace a two-wire process transmitter.

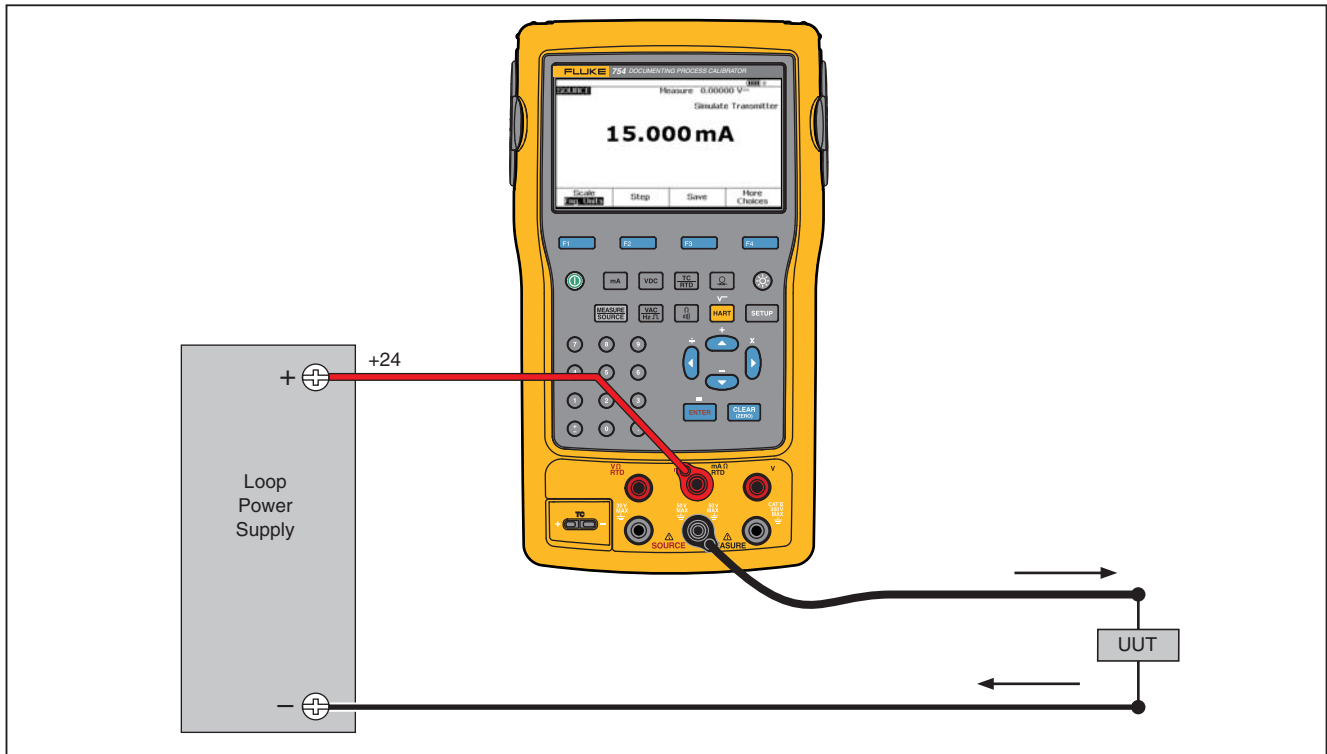

gks17c.eps

Figure 19. Connections to Simulate a 4 to 20 mA Transmitter

Supply Loop Power

The Product supplies loop power at 26 V dc through an internal series resistance of 250 Ω . The setting supplies sufficient current for two or three 4-20 mA devices on the loop.



When you use loop power, the mA jacks are dedicated to measuring the current loop. This means that the SOURCE mA, measure RTD, and measure Ω functions are not available (see Table 10.)

Connect the Product in series with the instrument current loop as Figure 20 shows. To supply loop power:

1. Push **SETUP** for Setup mode.

Note

Loop Power, Disabled is highlighted.

2. Push  and  to select **Disabled** or **Enabled**.
3. Push **ENTER**.
4. Push the **Done** softkey. “**LOOP**” is shown on the display when Loop Power is in operation.

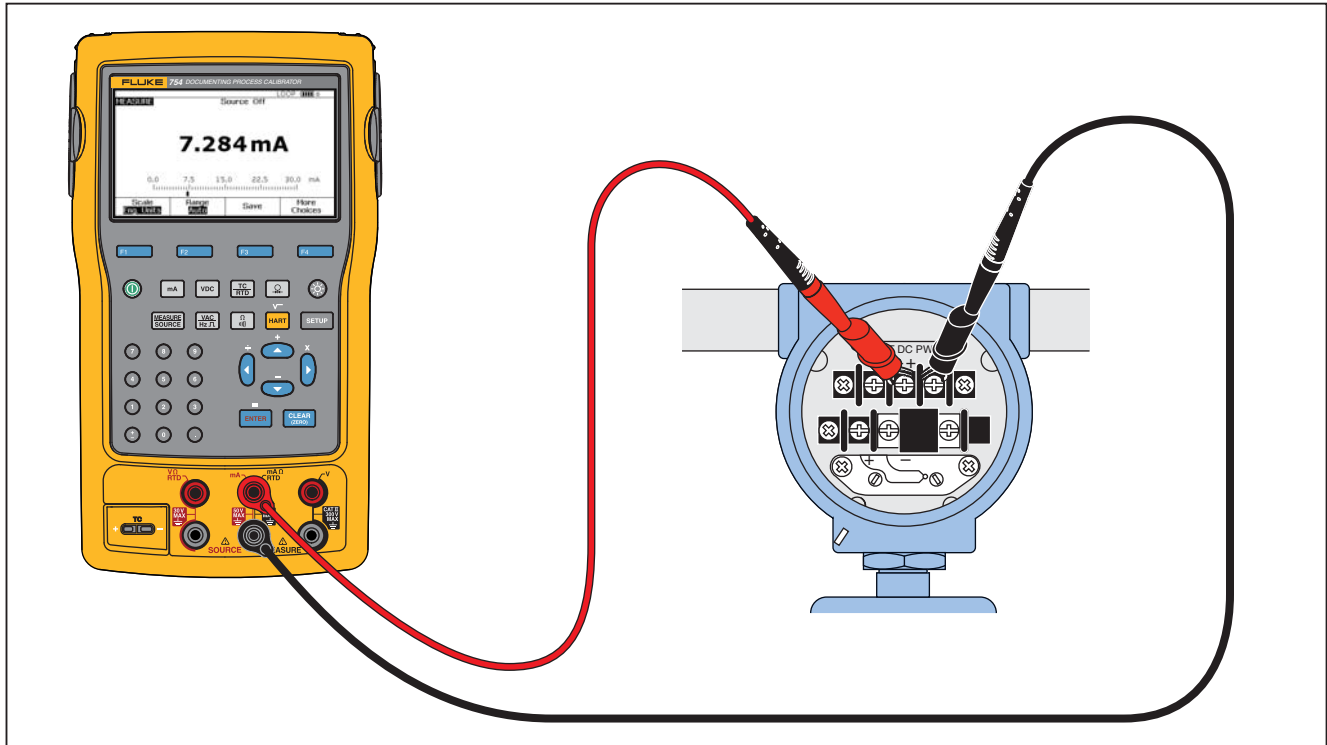

gks18c.eps

Figure 20. Connections to Supply Loop Power

Source Pressure

The Product has a source pressure display function where an external pressure hand pump is necessary. Use this function to calibrate instruments where a pressure source or differential pressure measurement is necessary. See Figures 21 and 36 for information about that application.

Many ranges and types of pressure modules are available from Fluke, see “Accessories”. Before you use a pressure module, read its instruction sheet. The modules are different in how they are used, zeroed, what types of process pressure media are allowed, and accuracy specifications.

To use the source pressure display, see Figure 21:







Warning

To avoid a violent release of pressure in a pressurized system, shut off the valve and slowly bleed off the pressure before attaching the pressure module to the pressure line.

Caution

To avoid mechanically damaging the pressure module:

- **Never apply more than 10 ft.-lb. of torque between the pressure module fittings or between the fittings and the body of the module.**
- **Always apply correct torque between the pressure module fitting and connecting fittings or adapters.**
- **To avoid damaging the pressure module from overpressure, never apply pressure above the rated maximum printed on the pressure module.**
- **To avoid damaging the pressure module from corrosion, use it only with specified materials. See the printing on the pressure module or the pressure module instruction sheet for the acceptable material compatibility.**

1. Connect a pressure module and pressure source to the Product as Figure 21 shows. The threads on the pressure modules accept ¼ NPT fittings. Use the supplied ¼ NPT to ¼ ISO adapter if necessary.
2. If necessary, push  for SOURCE mode.
3. Push . The Product automatically senses which pressure module is attached and sets its range accordingly.
4. Zero the pressure module as described in the module's instruction sheet. The module types are different in how they are zeroed. The pressure module **MUST** be zeroed before doing a task that sources or measures pressure.
5. Pressurize the pressure line with the pressure source to the necessary level as shown on the display.
6. If necessary, change the pressure display units to psi, mHg, inHg, inH₂O, ftH₂O, mH₂O, bar, Pa , g/cm², or inH₂O@60°F. Metric units (kPa, mmHg, etc.) are shown in Setup mode in their base units (Pa, mHg, etc.).
To change the pressure display units:
 1. Push .
 2. Push **Next Page** twice.
 3. Push  with the cursor on **Pressure Units**.
 4. Select the pressure units with  or .
 5. Push .
 6. Push the **Done** softkey.

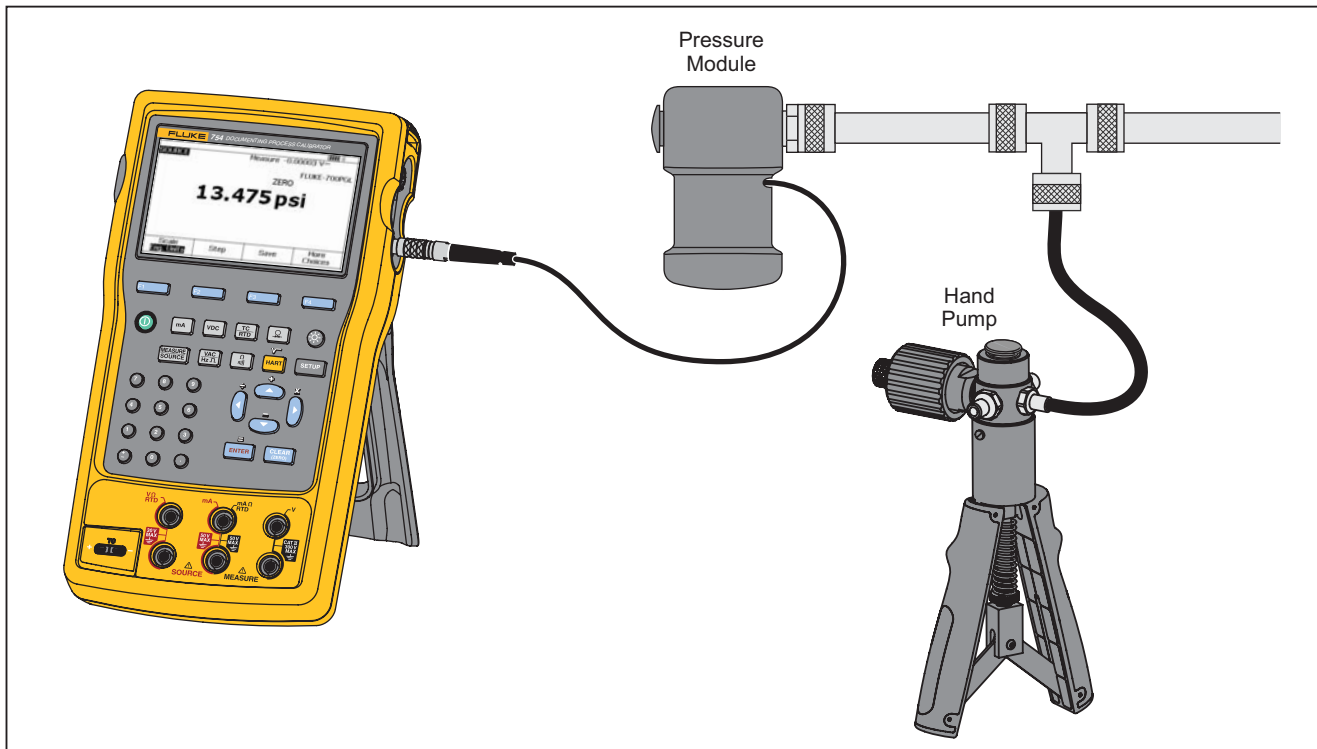

gks19c.eps

Figure 21. Connections to Source Pressure

Thermocouple Simulation

Note

See “Temperature Measurement” for a table of thermocouple types that are supported by the Product.









Connect the Product TC input/output to the instrument under test with thermocouple wire and the correct thermocouple mini-connector (polarized thermocouple plug with flat, in-line blades spaced 7.9 mm (0.312 in) center to center).

⚠ Caution

To prevent possible damage to the Product, do not try to force a miniplug in the wrong polarization. One pin is wider than the other.

Figure 19 shows this connection. To simulate a thermocouple:

1. Attach the thermocouple leads to the correct TC miniplug, and then to the TC input/output. See Figure 15.
2. If necessary, push  for SOURCE mode.

3. Push , and then push  to select the TC sensor type. The display asks you to select the thermocouple type.
4. Push  or  followed by  to select the necessary thermocouple type.
5. Push  or  followed by  to select Linear T (default), or Linear mV, (to calibrate a temperature transmitter that responds linearly to millivolt inputs).
6. Record the temperature to simulate as prompted by the display and push .

Note

*If you use copper wire instead of thermocouple wire, the reference junction is no longer inside the Product. The reference junction moves to the instrument (transmitter, indicator, controller, etc.) input terminals. The external reference temperature must be measured accurately and recorded into the Product. To do this, push  and set **Ref. Junc. Compensat.** and **Ref. Junc. Temp.**. After you record the external reference temperature, the Product corrects all voltages to adjust for this new reference junction temperature.*









RTD Simulation

Note

See Table 8 for data about RTD (Resistance-Temperature Detector) types compatible with the Product.

Connect the Product to the instrument under test as shown in Figure 23. The figure shows connections for two, three, or four-wire transmitters. For three or four-wire transmitters, use the 4-inch long stackable jumper cables to connect the third and fourth wires at the source $V \Omega$ RTD jacks.

To simulate an RTD (Resistance-Temperature Detector):

1. If necessary, push  for SOURCE mode.
2. Push .
3. Push  or  to select RTD.
4. Push . The Select RTD Type display is shown.
5. Push  or  followed by  to select the necessary RTD type.
6. The product tells you to use the keypad to enter the temperature to simulate. Input the temperature, and then push .

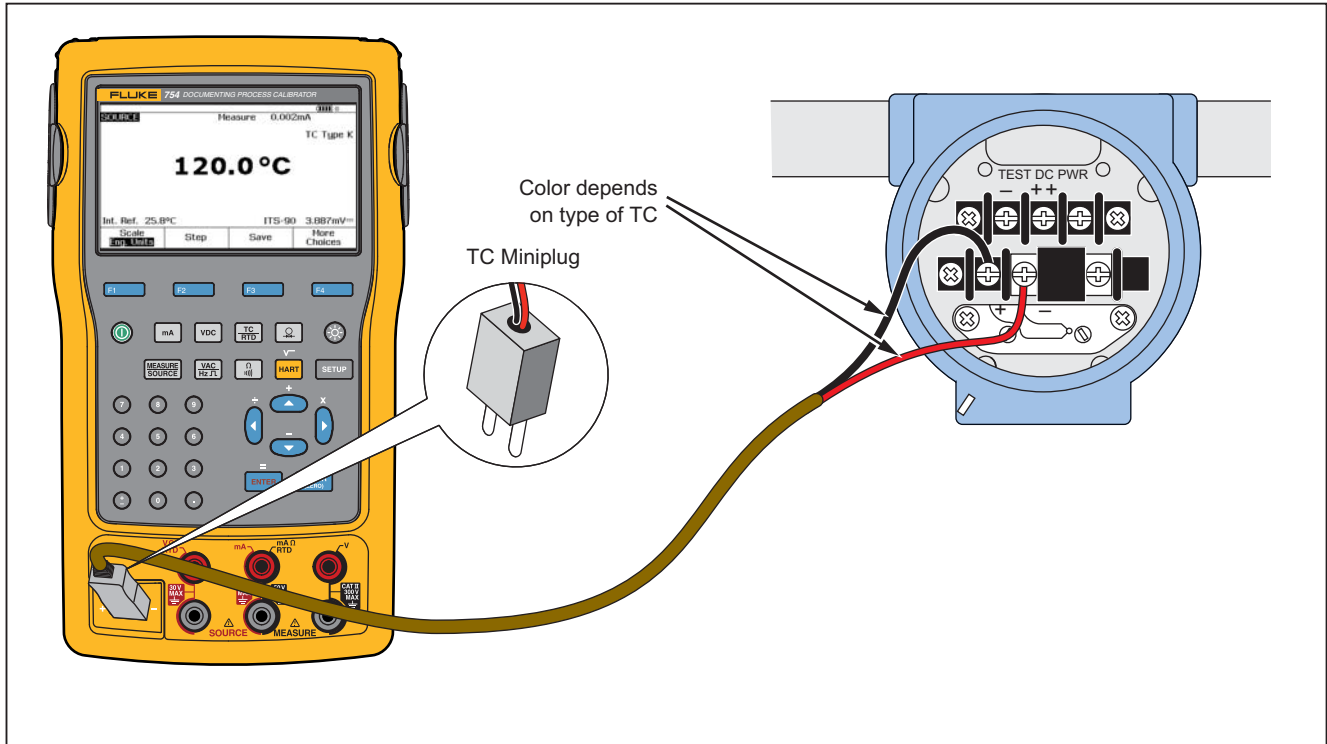

gks20c.eps

Figure 22. Connections to Simulate a Thermocouple

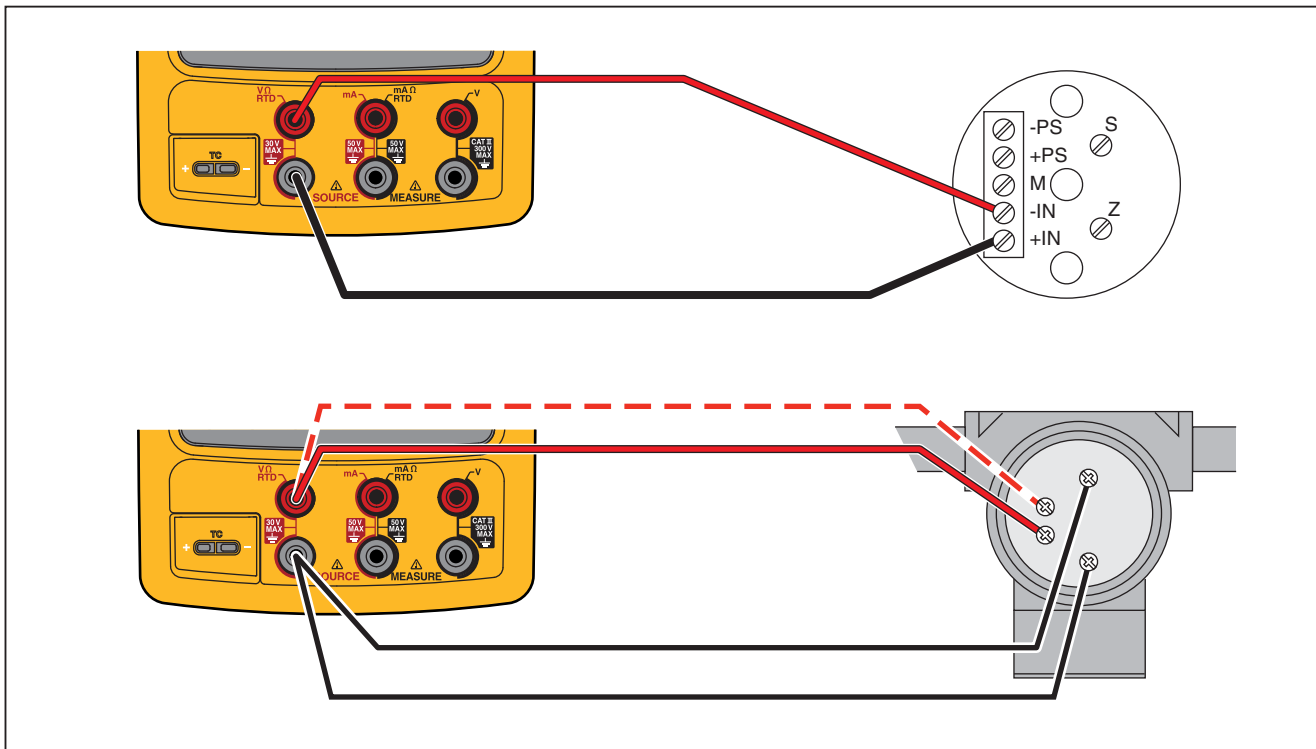

gks21f.eps

Figure 23. Connections to Simulate an RTD

Source Temperature with a Hart Scientific Drywell



The Product can source temperature using a Hart Scientific Drywell. Many models are supported.

The drywell driver is able to talk to other drywells from Hart Scientific, provided that they respond to Hart Scientific's standard serial interface commands.

Connect the Product to the drywell by plugging the drywell interface cable into the pressure module connector as shown in Figure 24. If the drywell has a DB9 connector, plug the drywell interface cable directly into the drywell using the DB9 Null Modem adapter. Drywells with the 3.5 mm jack connector need to use the serial cable supplied with the drywell in addition to the Product drywell interface cable. Join the DB9 connectors of the two cables, and connect the 3.5 mm jack to the drywell.

Be sure the drywell is configured for serial communication at 2400, 4800, or 9600 bits per second. Other rates are not supported by the Product.

To source a temperature with a drywell:

1. If necessary, push  for SOURCE mode.
2. Push  to display the temperature mode menu.
3. Select **Drywell** from the list of options, and press .
4. The Product will begin to search for a drywell. If the Product shows **Attempting connection** for more than

10 seconds, double check your cable connections and drywell configuration.

5. If a dual well is recognized, a menu will pop up that allows you to select a "hot" or "cold" side of the dual well. Only one side of the drywell may be controlled at a time. Switching sides requires the drywell to be reconnected, by disconnecting the serial cable or by leaving drywell source mode and selecting it again.
6. When the drywell is connected, the primary display will show the actual temperature of the drywell, as measured by the drywell internally. The drywell model number will appear above the primary reading. The setpoint for the drywell is displayed in the secondary display, at the bottom of the screen. Initially, the setpoint will be set to the value already stored in the drywell.
7. Enter the temperature you wish to source and press .

The settled indicator will be cleared when the actual temperature is within one degree of the setpoint, and the actual temperature is not changing quickly. Refer to the drywell documentation for that model's recommendations for stabilization time.

The upper temperature limit is restricted by the "High Limit" setting stored in the drywell. If the Product will not set the drywell to temperatures within the drywell spec, refer to the drywell manual to check the "High Limit" setting.

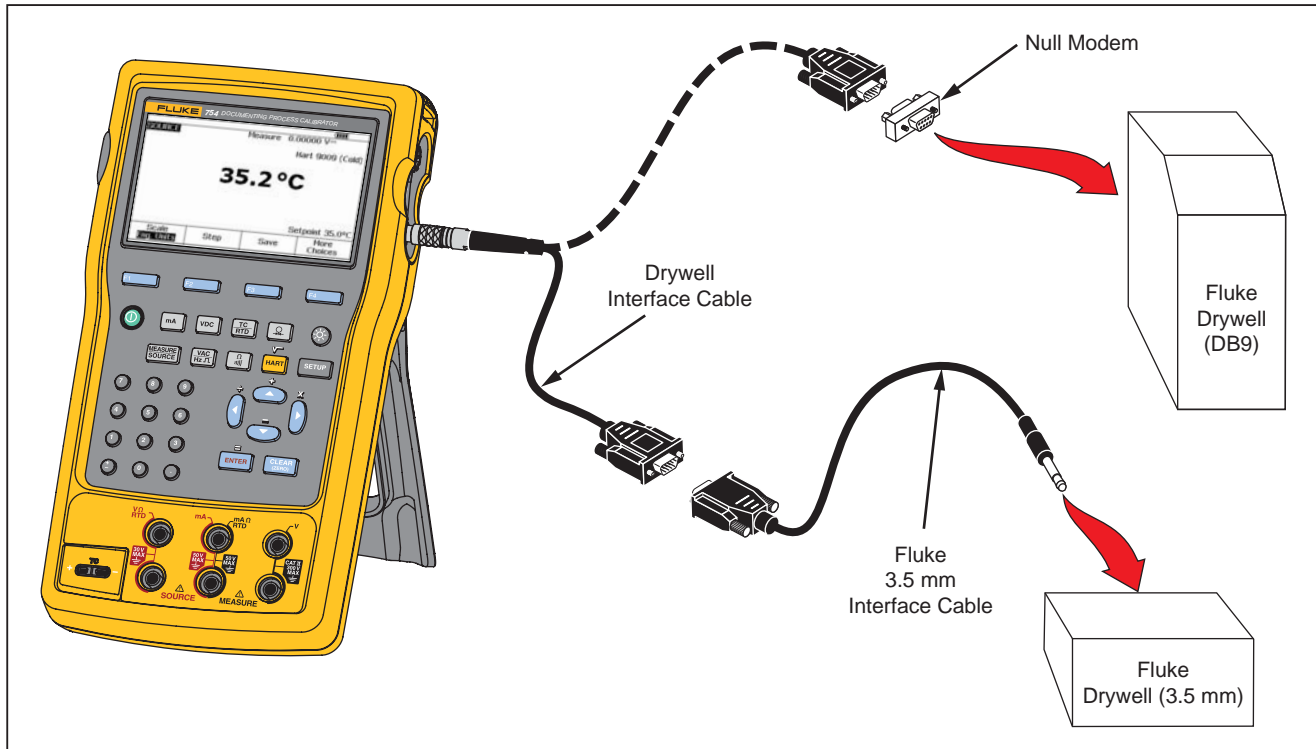

gks99f.eps

Figure 24. Source Temperature with Drywell

Note

When the Product is set to display temperatures in Kelvin, the drywell readout will show Celsius, and when the Product shows Rankine, the drywell will show Fahrenheit.

Source Scale

This feature scales the output in accordance with the input requirements of an applicable process instrument's response. Percent of scale can be used for linear-responding transmitters, or square-root responding transmitters.

Linear-Responding Transmitters

1. If necessary, push **MEASURE SOURCE** for SOURCE mode.
2. Select a source function (**mA**, **VDC**, **VAC Hz/Vt**, **Ω**, **TC RTD**, or **Ω**) as previously described, and record a value.
3. Push the **Scale** softkey.
4. Select % from the list.
5. Push **ENTER**.
6. Use the numeric keypad to record the 0% of scale value (**0% Value**).
7. Push **ENTER**.
8. Use the numeric keypad to record the 100% of scale value (**100% Value**).

9. Push the **Done** softkey.

Percent of scale stays in effect until you change to a different source function or until the **Scale** softkey is pushed and you select a different scale mode.

Square-Root Process Variables



When you select $\sqrt{\quad}$ within scaling, the Product output value is the percent value recorded, squared, and converted to engineering units.

1. If necessary, push **MEASURE SOURCE** for SOURCE mode.
2. Select a source function (**mA**, **VDC**, **VAC Hz/Vt**, **Ω**, **TC RTD**, or **Ω**) as previously described, and record a value.
3. Push the **Scale** softkey.
4. Select $\sqrt{\quad}$ from the list.
5. Use the numeric keypad to record the 0% of scale value (**0% Value**).
6. Push **ENTER**.
7. Use the numeric keypad to record the 100% of scale value (**100% Value**).
8. Push **ENTER**.
9. Push the **Done** softkey.

Square root percent of scale is in effect until the Product is changed to a different source function or the **Scale** softkey is pushed and you select a different scale mode.

Step and Ramp the Output Value

Two features are available that let you adjust the value of source functions, except pressure. For pressure, an external pressure source must be used:



- Step the output manually with  and , or in automatic mode.
- Ramp the output with optional continuity or V trip detect.

Manual Step Use

The manual **Step** feature selects a step size in engineering units (mV, V, mA, °C, etc.) or % of scale. Step the output in % of scale to quickly jump between 0 % and 100 % (set step size = 100 %) or 0-50-100 % (set step size = 50 %). Step works in SOURCE and in MEASURE/SOURCE modes.

To select a step size:

1. See the applicable Source Mode subheading in this manual (for example, “Source Electrical Parameters”) and connect the Product to the test circuit.
2. If necessary, push  for SOURCE mode.
3. Set the Product for the necessary source value.

4. To step the source value in % of scale, set the % of scale value as given before in “Measurement Scale”.
5. Push the **Step** softkey.
6. Use the numeric keypad to record the step size in the units shown on the display.
7. Push the **Done** softkey.
8. Push  and  to adjust the output in steps.

Auto Step Use

To configure the Product to make a sequence of steps automatically, either once through the sequence or repetitively:

1. See the applicable Source Mode subheading in this manual (for example, “Source Electrical Parameters”) and connect the Product to the test circuit.
2. If necessary, push  for SOURCE mode.
3. Set the Product for the necessary source value.
4. To step the source value in % of scale, set the % of scale value as given before in “Measurement Scale”.
5. Push the **Step** softkey.
6. Push the **Auto Step** softkey.

7. The display tells you to select values for these parameters:

- Start point (in units or % of scale)
- End point
- Number of steps
- Time per step
- Repeat mode, single shot or continuous repetition
- Step style, Sawtooth or Triangle pattern
- Start delay

Push the **Start Step** softkey to automatically start the step function. The softkey label changes to **Stop Step**.

8. To Push the **Stop Step** softkey to stop the automatic step function.
9. Push the **Done** softkey to continue normal operation.

Ramp the Output

When ramped, the source sweeps up or down in value. Use the ramp feature to check a switch or alarm, or when a smooth increase or decrease of the output function is necessary. The Product can be set to ramp up or down in engineering units (mV, V, mA, °C, etc.) or % of scale.

While the signal ramps, the output is adjusted 4 times per second. The size of the steps is bound by the selection of endpoints and ramp time. For example, if you set the Product to ramp from 1 mV to 1 V over 10 seconds, the output is adjusted in approximately 25 mV steps.

The Ramp function continues until you get the selected limit, or until an optional trip condition is met. The optional trip detect works as follows: during ramping, the Product checks for either a 1 V change in dc voltage or a change in continuity status (**Open** or **Short**) from one ¼ second interval to the subsequent interval.

To ramp (for example, sweep the source):

1. See the applicable section earlier in this manual (for example, “Source Electrical Parameters”) and connect the Product to the test circuit.
2. To automatically stop the Ramp function if a trip condition is sensed, connect a voltage trip circuit to the V MEASURE jacks or a continuity trip circuit to the mA Ω RTD MEASURE jacks. (Continuity detection is not available when sourcing current.)
3. If necessary, push  for SOURCE mode.
4. Set the Product for the necessary source value as given before.
5. To Ramp the output in % of scale, set % of scale as given before under “Measurement Scale”.
6. Push the **More Choices** softkey.
7. Push the **Ramp** softkey. The display changes to the screen shown Figure 25.
8. Record the parameters given. Record the **Start Value**, **End Value**, and **Ramp Time**.
9. To automatically stop the Ramp function if a trip condition is sensed, set the **Trip Detect** to **Enabled**, and select **Voltage** or **Continuity** as the trip function.

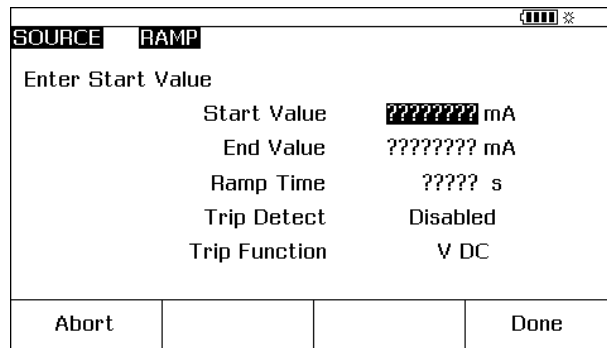

gks41s.bmp

Figure 25. Ramp Screen

10. Push the **Done** softkey. Note **RAMP** next to **SOURCE** at the top of the display.
11. Select a low-to-high ramp or a high-to-low ramp with the **Ramp Up/Down** softkey.
12. To start the Ramp function, push the **Start Ramp** softkey.
13. The Ramp function continues until a trip is sensed (if enabled), the ramp time expires, or the **Stop Ramp** softkey is pushed. See Figure 26.

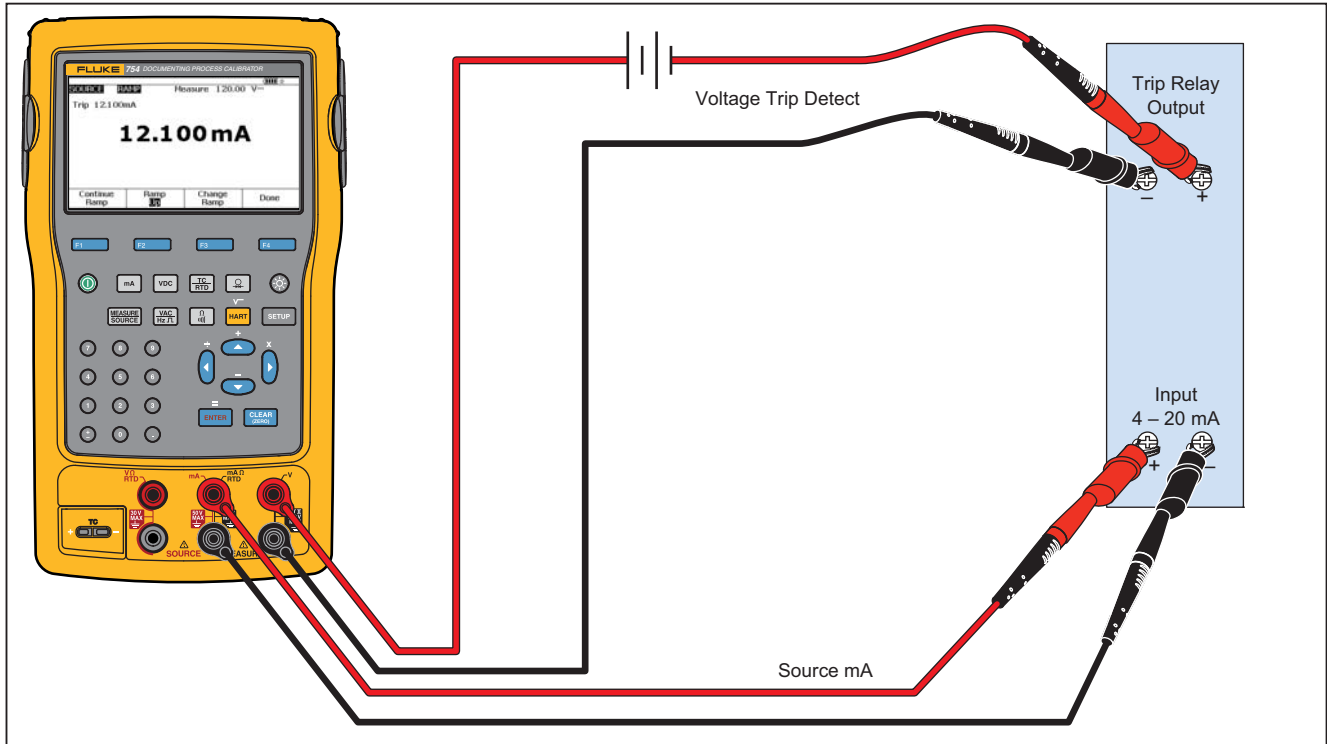

gks22c.eps

Figure 26. Check a Relay Output Trip Alarm

Simultaneous Measure/Source

Use the MEASURE/SOURCE mode to calibrate or emulate a process instrument. Push  so that a split screen display shows as in Figure 27.

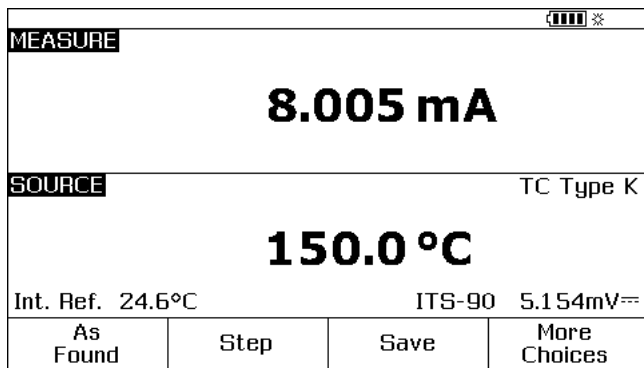

Figure 27. Measure and Source Screen

Table 9 shows the functions that can be used at the same time when Loop Power is disabled. Table 10 shows the functions that can be used at the same time when Loop Power is enabled.

Step or **Auto Step** features can be used to adjust the output in MEASURE/SOURCE mode, or use the calibration routine given when the **As Found** softkey is pushed.

Use the two softkeys shown in MEASURE/SOURCE mode when you calibrate a process instrument:

- **As Found**, which can be used to set up a calibration routine to get and record as found data.
- **Auto Step**, which can be used to set up the Product for auto-stepping, as given before.

Table 9. Simultaneous MEASURE/SOURCE Functions with Loop Power Disabled

Measure Function	Source Function						
	dc V	mA	Freq	Ω	TC	RTD	Pressure
dc V	•	•	•	•	•	•	•
mA	•		•	•	•	•	•
ac V	•	•	•	•	•	•	•
Frequency (≥20 Hz)	•	•	•	•	•	•	•
Low Frequency (<20 Hz)							
Ω	•		•	•	•	•	•
Continuity	•		•	•	•	•	•
TC	•	•	•	•		•	•
RTD	•		•	•	•	•	•
3W RTD	•		•	•	•	•	•
4W RTD	•		•	•	•	•	•
Pressure	•	•	•	•	•	•	

Table 10. Simultaneous MEASURE/SOURCE Functions with Loop Power Enabled

Measure Function	Source Function						
	dc V	mA	Freq	Ω	TC	RTD	Pressure
dc V	•		•	•	•	•	•
mA	•		•	•	•	•	•
ac V	•		•	•	•	•	•
Frequency (≥ 20 Hz)	•		•	•	•	•	•
TC	•		•	•		•	•
Pressure	•		•	•	•	•	

Process Instrument Calibration

Note











To calibrate a HART-capable transmitter using the built-in HART interface, see the 754 HART Mode Users Guide for instructions.

When the Product is in MEASURE/SOURCE, a built-in calibration routine can be configured when the **As Found** softkey is pushed. As Found data is the test results that show the condition of a transmitter before it is adjusted. The Product can run preloaded tasks that are developed with a host computer and *DPCTrack2* application software. See “Communication with a PC”.

Generate “As Found” Test Data

The subsequent example shows how to supply as found data for a thermocouple temperature transmitter.

Here, the Product simulates the output of a thermocouple and measures the current regulated by the transmitter. Other transmitters use this same procedure. Go back to MEASUREMENT or SOURCE mode and change the operation parameters before you push **As Found**.

1. Connect the test leads to the instrument under test as shown in Figure 30. The connections simulate a thermocouple and measure the corresponding output current.
2. If necessary, push  for MEASURE mode.
3. Push .
4. Push  for SOURCE mode.
5. Push  and  to select TC sensor.
6. Push  and  to select the thermocouple type.
7. Push  to select then  to select Linear T source mode.
8. Record a source value, for example 100 degrees, and then push .

9. Push **MEASURE/SOURCE** for MEASURE/SOURCE mode. The display changes to the screen shown in Figure 28.

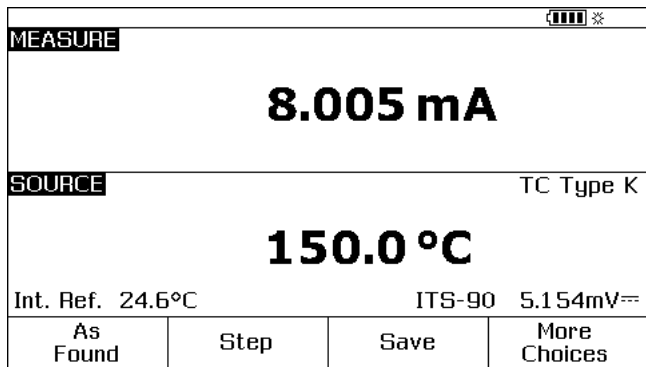

Figure 28. Process Instrument Calibration Screen

10. Push the **As Found** softkey, followed by the **Instrument** selection (**ENTER**).

The display changes to the screen shown in Figure 29.

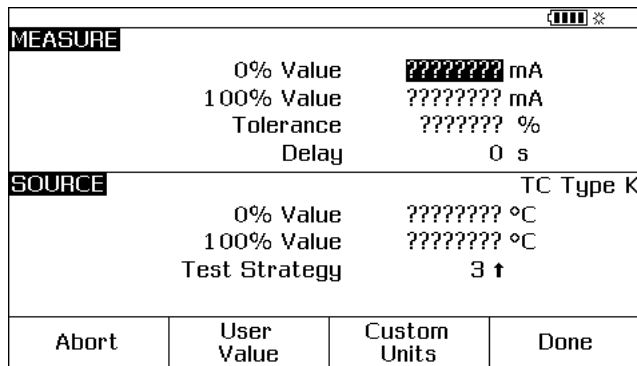
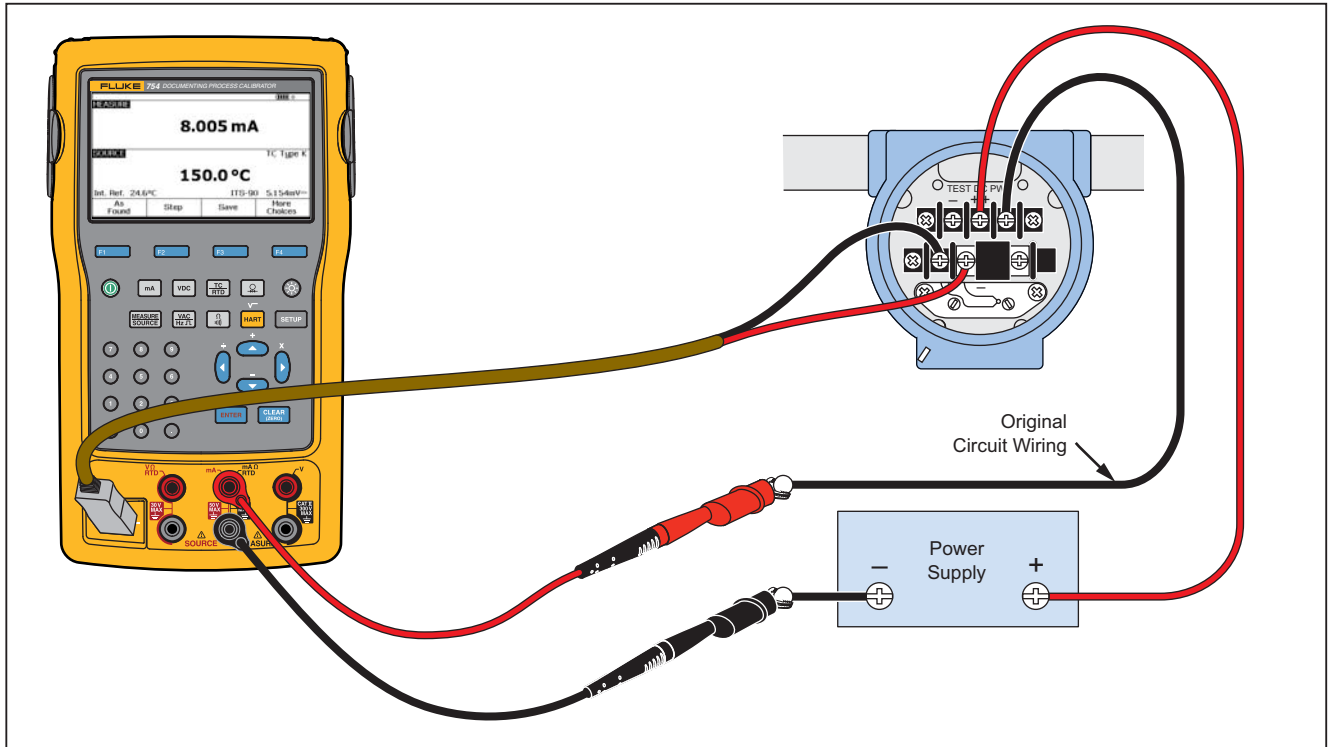



Figure 29. Process Instrument Calibration Screen 2

11. Record values for **0%** and **100%** of 4.0 mA and 20.0 mA, in that sequence. Set **Tolerance** to 0.5% of span.



gks23c.eps

Figure 30. Calibrate a Thermocouple Temperature Transmitter

12. More delay time can be input for the process instrument to become stable than the Product's usual settling time (about 2 seconds). To change the delay time, input that time in seconds for **Delay**.
13. Push  and  to move the cursor down to record **0%** and **100%** values for SOURCE temperature. Our example uses 100 °C and 300 °C.
14. If the instrument calibration procedure requires you to manually record the measurement value or source, push the **User Value** softkey, for user-recorded values.

Custom Units lets you specify user units such as PH. See "Creating Custom Measurement Units", given before in this manual for an example.

When you use custom units,  is shown next to the value on the display and in results.

Push the **Done** softkey after the custom unit has been programmed.

15. The **Test Strategy** is the number of test points and which test points are performed rising and falling in percent of scale. This example uses five points (0 %, 25 %, 50 %, 75 %, and 100 %), rising only. Rising is indicated by the up arrow on the display. Push  to change to a different test strategy on this line. A list of strategies is shown from which to choose. Select one, and then push the **Done** softkey.
16. When you are done recording the calibration parameters, the display should change to the screen shown in Figure 31.

[Battery Icon] *			
MEASURE			
	0% Value	4.000 mA	
	100% Value	20.000 mA	
	Tolerance	0.50 %	
	Delay	0 s	
SOURCE			
		TC Type K	
	0% Value	100.0 °C	
	100% Value	300.0 °C	
	Test Strategy	5 ↑	
Abort	User Value	Custom Units	Done

gks45s.bmp

Figure 31. Calibration Parameters Screen

17. Push the **Done** softkey to accept the calibration parameters. The display changes to the screen shown in Figure 32.

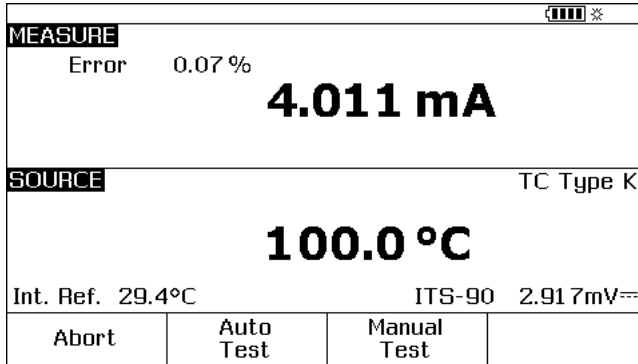

gks46s.bmp

Figure 32. Measure and Source Screen for Calibration

18. At this time you can do an automatic test or step through the test points manually. Push the **Auto Test** softkey to have the Product go through the tests automatically. If necessary, push **Abort** to exit from the calibration procedure. The tests start at the first test point, sources the correct temperature and measures the corresponding current from the transmitter.

When a measurement is stable and recorded, the Product goes to the subsequent step. Because the Product waits until the measurement becomes stable, the Auto Test works as necessary for instruments with built-in damping. The error of the expected measured value is shown in the top left of the measure window.

19. The Product moves to the remaining set of points. For temperature and electrical parameter calibration, the points are done automatically. If your source pressure, the Product stops at each step to let you adjust the pressure source. When the tests are complete, an error summary table similar to Figure 33 is shown.

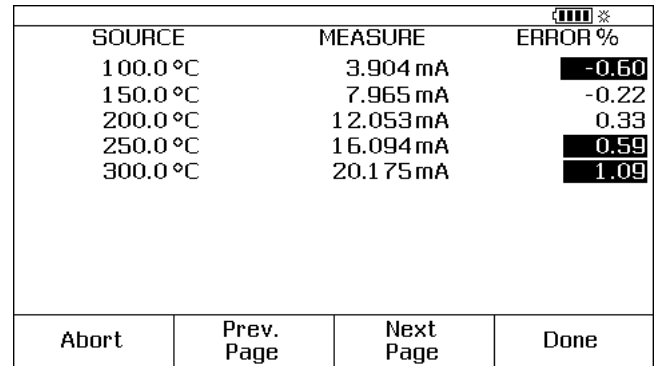

gks47s.bmp

Figure 33. Error Summary Screen

In the results summary test, failures are highlighted. An adjustment is necessary in this example because three tests show failures. The failures were outside the ± 0.5 % tolerance that was selected.

20. Push the **Done** softkey to keep the data, or the **Abort** softkey to erase the data and start again.

See the data entry that was recorded and recall the table later with the **Review Memory** softkey during normal operation. This data can be uploaded to a host computer that runs compatible *DPCTrack2* application software. See "Communication with a PC".

Transmitter Adjustment

Note

Always read the transmitter manufacturer's instructions to find the adjustment controls and connection points for your transmitter.

To make calibration adjustments to the transmitter:

1. Push the **Done** softkey after you review the results summary.
2. Push the **Adjust** softkey. The Product sources 0 % of span (100 °C in this example) and shows these softkeys:
 - **Go to 100%/Go to 0%**
 - **Go to 50%**
 - **As Left**
 - **Done**
3. Adjust the transmitter output for 4 mA and then push the **Go to 100%** softkey.
4. Adjust the transmitter output for 20 mA. If HART adjustments (output Trim and Sensor trim) are necessary, please refer to the *754 HART Mode Users Guide*.
5. If the span was adjusted in step 4, do steps 3 and 4 until adjustment is no longer necessary.
6. Examine the transmitter at 50 %. If it is in specification, the adjustment is done. If not, adjust the linearity and start this procedure again at step 3.

“As Left” Test Run

Proceed as follows to generate and record as *left* data for the thermocouple temperature transmitter that was adjusted.

1. Push the **As Left** softkey to record as *left* data.
2. Push the **Auto Test** softkey to start an automatic sequence through all the test points, or step through the tests manually.
3. When the tests are complete, read the error summary table. See Figure 34.

SOURCE	MEASURE	ERROR %
100.0 °C	3.966 mA	-0.21
150.0 °C	7.991 mA	-0.06
200.0 °C	12.029 mA	0.18
250.0 °C	16.023 mA	0.14
300.0 °C	19.983 mA	-0.11

Abort	Prev. Page	Next Page	Done
-------	------------	-----------	------

gks48s.bmp

Figure 34. As Left Data Screen

Unsettled measure or source values are highlighted. This means that there was an unsettled value (~) annunciator) when the measurement was taken.

4. If all the results are in specification, as they are here, push the **Done** softkey. An entry in memory is made for as *left* data.

Test Comments

The Product does tasks (custom procedures) that are made with a host computer and *DPCTrack2* application software. See “Communication with a PC”. A task can show a list of proposed comments as it operates. When the comment list is shown, push (up) and (down) and then [ENTER] to select a comment to be kept with the test results.

Calibrate a Delta-Pressure Flow Instrument

The procedure to calibrate a $\sqrt{\quad}$ instrument is the same as for other instruments, as given before, with these differences:

- Source square-root is automatically enabled after the **As Found** calibration template is complete.
- Measure/Source displays are in engineering units.
- The measurement percentage is automatically corrected for the transmitter’s square-root response, and is used to calculate instrument errors.

Select the \surd instrument procedure in a menu after you push the **As Found** softkey.

Switch Calibration

The procedure to calibrate a switch also uses the As Found and As Left calibration templates. Select the **1 Pt. Switch** or **2 Pt. Switch** procedure in a menu after you push the **As Found** softkey. Figure 35 specifies the terminology used when you calibrate limit switches.

The template to set up the switch procedure uses these parameters:



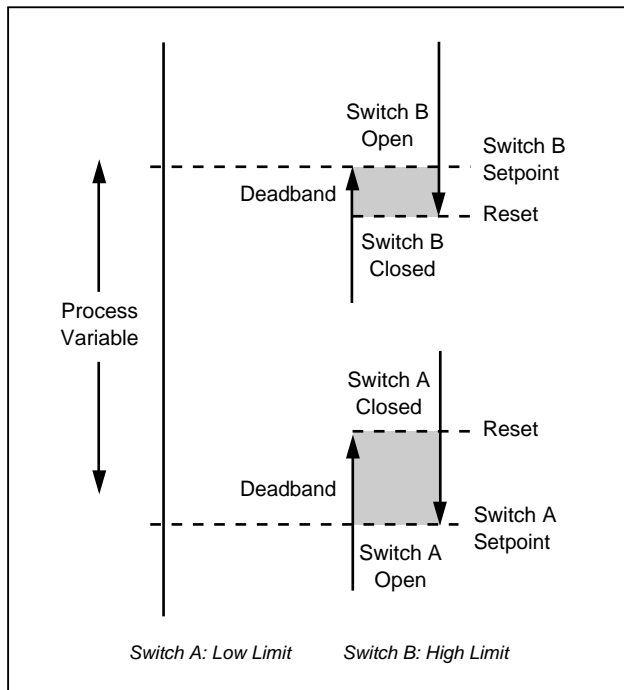





- Switch sense (normally open or closed)
- For each setpoint:
 - Setpoint value
 - Setpoint tolerance
 - High limit or low limit
 - Minimum deadband
 - Maximum deadband



gj24f.eps

Figure 35. Switch Terminology

To do a pressure switch test: The switch in this example sets at a high limit of 10 psi. The set condition is a closed switch contact. For pressure switches, use the **Manual Test** selection. For switches where sourcing pressure is not necessary, use the **Auto Test** selection to do the test.

1. Connect the test leads between the pressure switch contact output and the mA Ω RTD (center) jacks on the Product.
2. Connect the pressure module to the Product, and connect a pressure line to the switch. Keep the pressure line vented to atmosphere.
3. If necessary, push  for MEASURE mode.
4. Push  for the continuity measure function.
5. Push  for SOURCE mode.
6. Push  for the pressure source function.
7. Push  to zero the pressure module.
8. Push .
9. Push the **As Found** softkey.
10. Highlight **1 Pt. Switch Test** from the menu and push .
11. Push  to modify the parameters for Setpoint 1.
12. Make these selections:
Setpoint 1 = 10.000 psi
Setpoint Type = High
Set State = Short
13. Push the **Done** softkey.
14. Set the **Tolerance** to 0.5 psi.
15. The next parameters, **Deadband Min** and **Deadband Max**, are optional. Do not set them in this example. These parameters would describe the minimum allowable size of the deadband.

16. Push  to move through the choices to Set **Trip Function to Trip Cont.**
17. Push the **Done** softkey.
18. Push the **Manual Test** softkey.
19. Close the pressure line vent and slowly move the pressure up to the trip point.
20. When the switch sets, slowly decrease the pressure until the switch resets. If necessary, this cycle can be done again.
21. Push the **Done** softkey and see the results.
22. Push the **Done** softkey and if necessary, record **Tag, S/N,** and/or **ID.**
23. Push the **Done** softkey.
24. Exercise the switch by varying the applied pressure. Adjust the switch until the set point is correct.
25. Use the softkeys to control the Product, and adjust the switch as necessary.

26. Push the **Done** softkey.
27. Push the **As Left** softkey to start the test again with the same parameters. Results from the As Found and As Left tests are kept in Product memory to view later or upload.

The procedure for switches that respond to other parameters work similarly. When you do a 2 Pt. Switch Test, follow the directions given on the display for the first switch test, change test leads, and do the second switch test.

Transmitter Mode

The Product can be set so that a varying input (MEASURE) controls the output (SOURCE), like a transmitter. This is “Transmitter mode”. In Transmitter mode, you can use the Product temporarily as an alternative for a defective transmitter or for one that you think could be defective.



⚠ Warning



To avoid possible personal injury, do not use Transmitter mode in any environment that requires intrinsic safe equipment and practices.

⚠ Caution

Transmitter mode is for diagnostic purposes only. Use a completely charged battery. Do not use the Product in place of a transmitter for extended periods.

To set up the Product to emulate a transmitter:

1. Disconnect the control bus wires from the transmitter output (loop current or dc V control signal).
2. Connect test leads from the appropriate Product SOURCE jacks to the control wires in place of the transmitter.
3. Disconnect the process input (for example, thermocouple) from the transmitter.
4. Connect the process input to the applicable Product MEASURE jacks or input connector.
5. If necessary, push  for MEASURE mode.
6. Push the applicable function key for the process input.
7. Push  for SOURCE mode.

8. Push the applicable function key for the control output (for example,  or ). If the transmitter is connected to a current loop that has a power supply, select **Simulate Transmitter** for the current output.
9. Select a source value, for example, 4 mA.
10. Push  for MEASURE/SOURCE mode.
11. Push **More Choices** until the **Transmitter Mode** softkey is shown.
12. Push the **Transmitter Mode** softkey.
13. Set the 0 % and 100 % values for MEASURE and SOURCE on the display. **Linear** or $\sqrt{\quad}$ can be selected for the transfer function.
14. Push the **Done** softkey.

The Product is now in Transmitter mode. It measures the process input and sources the control signal output proportional to the input.

15. To change the Transmitter mode parameters, push **Change Setup**, and do the procedure in step 13 again.
16. To exit Transmitter mode, push the **Abort** softkey.

Memory Operations

Save Results

As Found/As Left test results are automatically kept at the end of each test routine. Any other time during MEASURE, SOURCE, or MEASURE/SOURCE, if necessary, push the **Save** softkey to keep the data on the display for later inspection.

After you push **Save**, the Product keeps the information on the display and shows a kept result index number, the date and time, and the percentage of memory available, as in Figure 36.

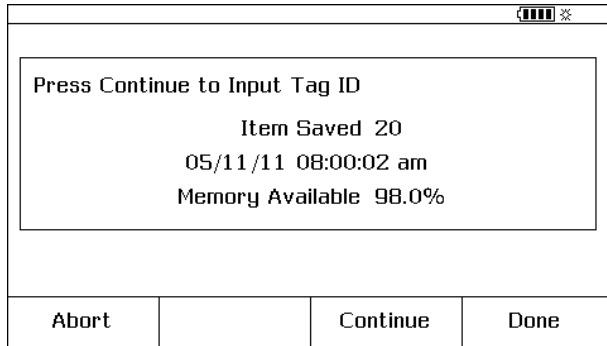

gks49s.bmp

Figure 36. Saved Data Screen

To add information to the kept data, push the **Continue** softkey, the display asks you to record the instrument tag identifier (**Tag**), instrument serial number (**S/N**), and operator name (**ID**), as shown in Figure 37.

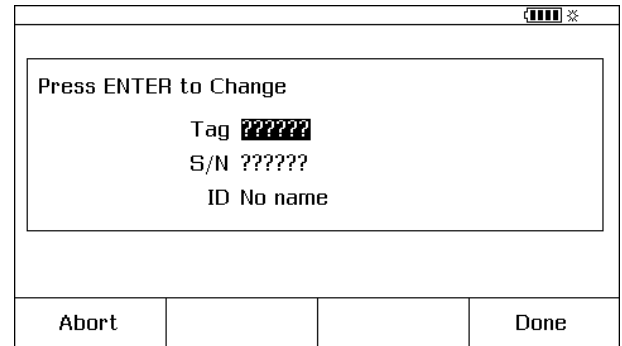

gks50s.bmp

Figure 37. Additional Data Input Screen

Record alphanumeric characters into the highlighted field with the optional bar code reader or the Product buttons.





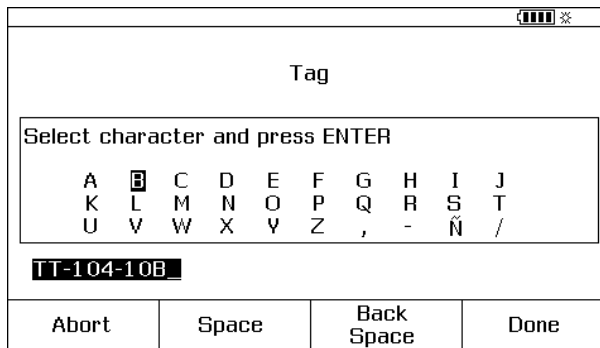

To record alphanumeric characters using the Product buttons, push  with the cursor on the necessary field to change (for example, Tag, above).

The display shows an alphanumeric entry window. See Figure 38.



gks51s.bmp

Figure 38. Alphanumeric Entry Window

1. Record numbers using the numeric keypad, and letters by highlighting the necessary character with , , , and  followed by . Push the **Space** softkey, followed by  to record a space character.
2. When the entry is complete, push the **Done** softkey.

Review the Memory

Push the **More Choices** softkey until **Review Memory** is shown, then push the **Review Memory** softkey to recall and see results that you have kept.

When the **Review Memory** softkey is pressed, the display changes to the screen shown in Figure 39.

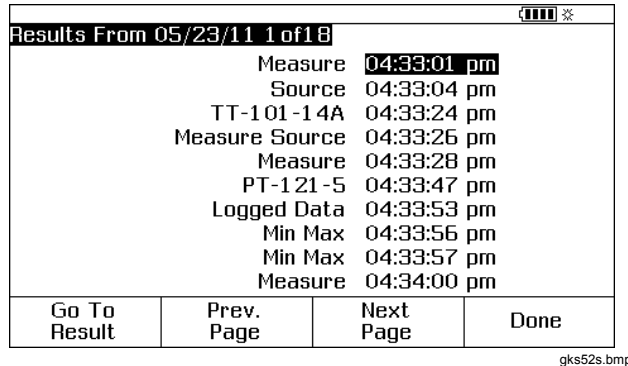

Figure 39. Memory Review Screen

Push \uparrow or \downarrow and **ENTER** or the **Go to Result** softkey to view a result that was kept.

Log Data

Users can record a series of measurements for later upload to a host computer that uses *DPCTrack2* application software. See "Communication with a PC". Up to 8000 readings can be recorded, depending on the reading rate, duration, and how much memory is being used for other things such as tasks or kept results. Record the reading rate and duration in minutes. See Figure 40.

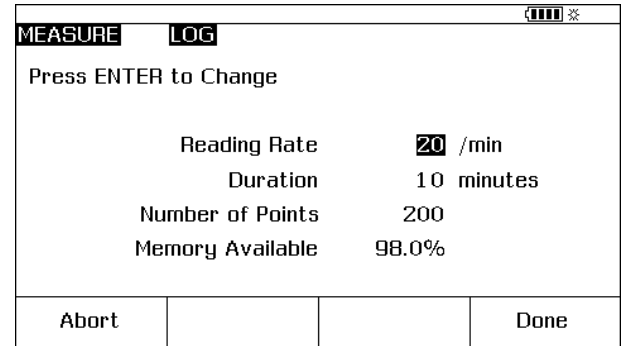

Figure 40. Data Log Parameters Screen

To log data:







1. If necessary, push  for MEASURE mode.
2. Push the **More Choices** softkey twice.
3. Push the **Log** softkey.
4. A list is shown; select a reading rate (1, 2, 5, 10, 20, 30, or 60 readings per minute). Push  or  to select the reading rate.
5. Push .
6. Push  to move the cursor to **Duration**.
7. Use the numeric keypad to record the duration in minutes, followed by . The maximum duration will depend on the reading rate and how much memory is available to log data.

Table 11 gives an estimate of the limits for duration, assuming that no memory is being used for other purposes.

Table 11. Duration Limits

Readings/Minute	Maximum Readings	Approximate Duration
1	8000	133 hours
2	8000	66 hours
5	8000	26 hours
10	8000	13 hours
20	8000	6 hours
30	7980	4 hours
60	7980	2 hours

⚠ Caution

To prevent possible damage to the Product, use a completely charged battery and the appropriate duration, or use the battery charger to avoid losing power during a logging session. If a low-battery condition occurs during a log session, the session is terminated and data collected to that point is kept. A long logging duration can exceed the life of a battery charge.

8. After the Product records the duration selection, the display shows how much memory that duration will consume. See the **Memory Available** percentage on the display. **Memory Available** indicates the percentage of available memory that will be used by the specified log.
9. Push the **Done** softkey. The display changes to the screen shown in Figure 41.

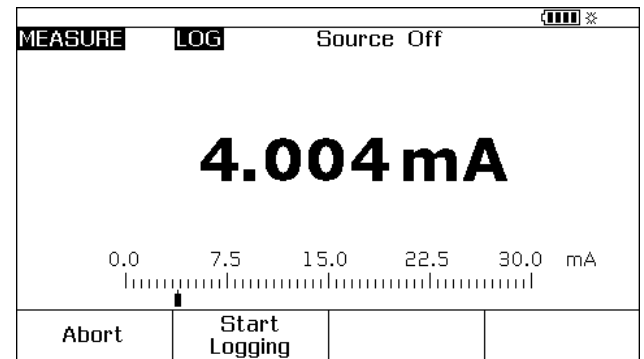

gks54s.bmp

Figure 41. Start Logging Screen

- Note the **LOG** annunciator next to **MEASURE**. Push the **Start Logging** softkey to record data.
- The Product continues to keep data points until the duration has passed, or until the **Done** softkey is pushed. If logging is stopped by these procedures the Product keeps the data as a memory item that can be uploaded to a host computer that uses *DPCTrack2* application software. See “Communication with a PC”.

Record Min and Max Measurements

You can set the display to record and show the maximum (max) and minimum (min) readings. Min and Max readings are always undamped, even if Dampen is On. Push the **More Choices** softkey twice, then push the **Min Max** softkey to energize this feature. Push  to reset the Min Max registers. Push the **Min Max** softkey again to revert to the normal display. Figure 42 shows the display with Min Max on.

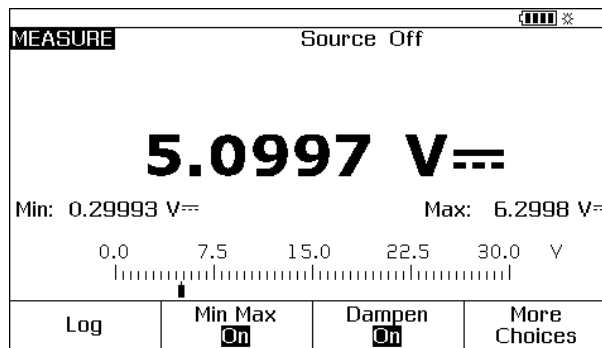

gks55s.bmp

Figure 42. Min Max Screen

Run a Preloaded Task

Push the **More Choices** softkey until the **Tasks** softkey is shown, then push **Tasks** to see the list of tasks (procedures) downloaded from a host computer. Tasks are Product configurations, kept with a procedure name, for example the type and manufacturer of a specific transmitter. A task configures the Product for transmitter calibration with all the calibration parameters (source and measure functions, 0% and 100% levels, test strategy) predefined.

While the task controls the Product, the **Continue** softkey becomes **Continue Task**.

Clear the Memory

In Setup mode, highlight the **Clear Memory** choice and push  to erase the memory:







- Results that have been kept
- Min Max data
- Log data sets

A confirmation message is shown so that the memory is not accidentally erased.

The Calculator

For mathematical equations that involve the Product's source or measured value, use the Product's built-in calculator. The current measure and source values and units, are always available to be put into an equation with one keystroke. The Product measures and sources during calculator operation.

Push the **Calc** softkey to start the calculator from the SOURCE, MEASURE, or MEASURE/SOURCE mode. Push the **More Choices** softkey to see the **Calc** softkey if necessary.

After you push **Calc**, the display, number keys, and keys with calculator functions (, , , ,  and ) become an algebraic-entry calculator.

Push the **Done** softkey to start normal Product operation.

Save to and Recall from the Registers

When the Product is in calculator mode, the top half of the display shows three register names and their contents:

- **MEASURE** (the present measured value)
- **SOURCE** (the present sourced value)
- **REGISTER** (temporary storage for your use)

Push the **Recall** softkey and then the softkey for the applicable register to insert the contents of any register into a calculation.

Push **Store** to copy the number from the calculator display (lower half) into **REGISTER** to temporarily save the number for later use, or into **SOURCE**.

Use the Calculator to Set the Source Value

When you store to **SOURCE**, the Product shows a selection of unit multipliers when necessary (for example, mV or V), then starts sourcing that value. The Product will not keep out-of-range values to **SOURCE**.

Quick Guide to Applications

The subsequent figures show test lead connections and which Product functions to use for many different applications.

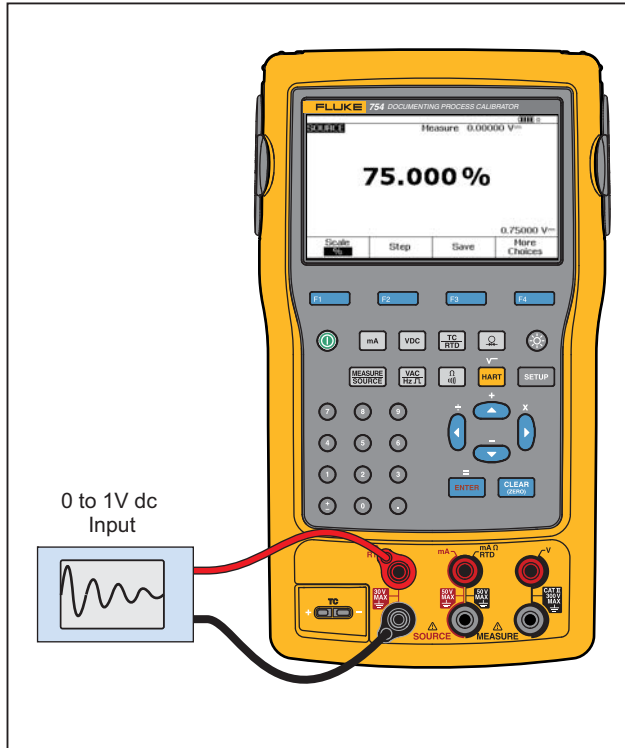

gks25c.eps

Figure 43. Chart Recorder Calibration

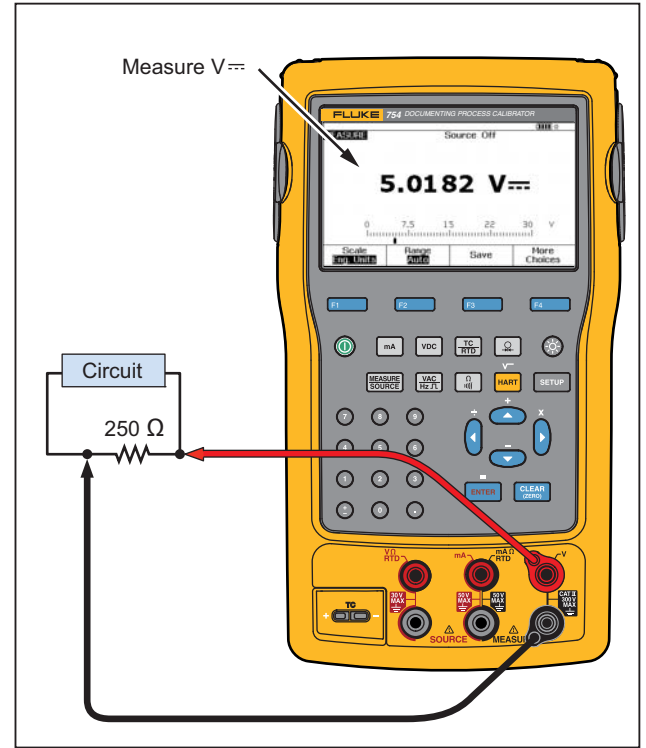

gks26c.eps

Figure 44. Voltage Drop Measurement

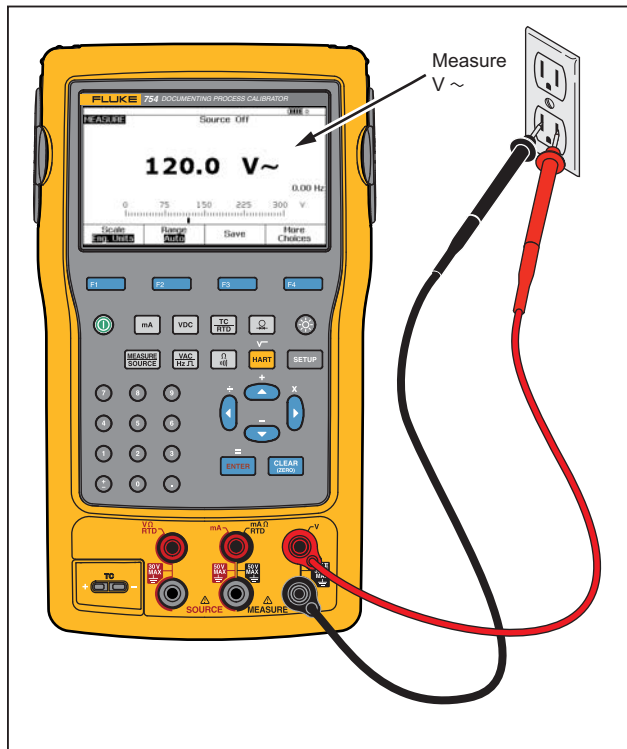

gks27c.eps

Figure 45. Monitor AC Line Voltage and Frequency

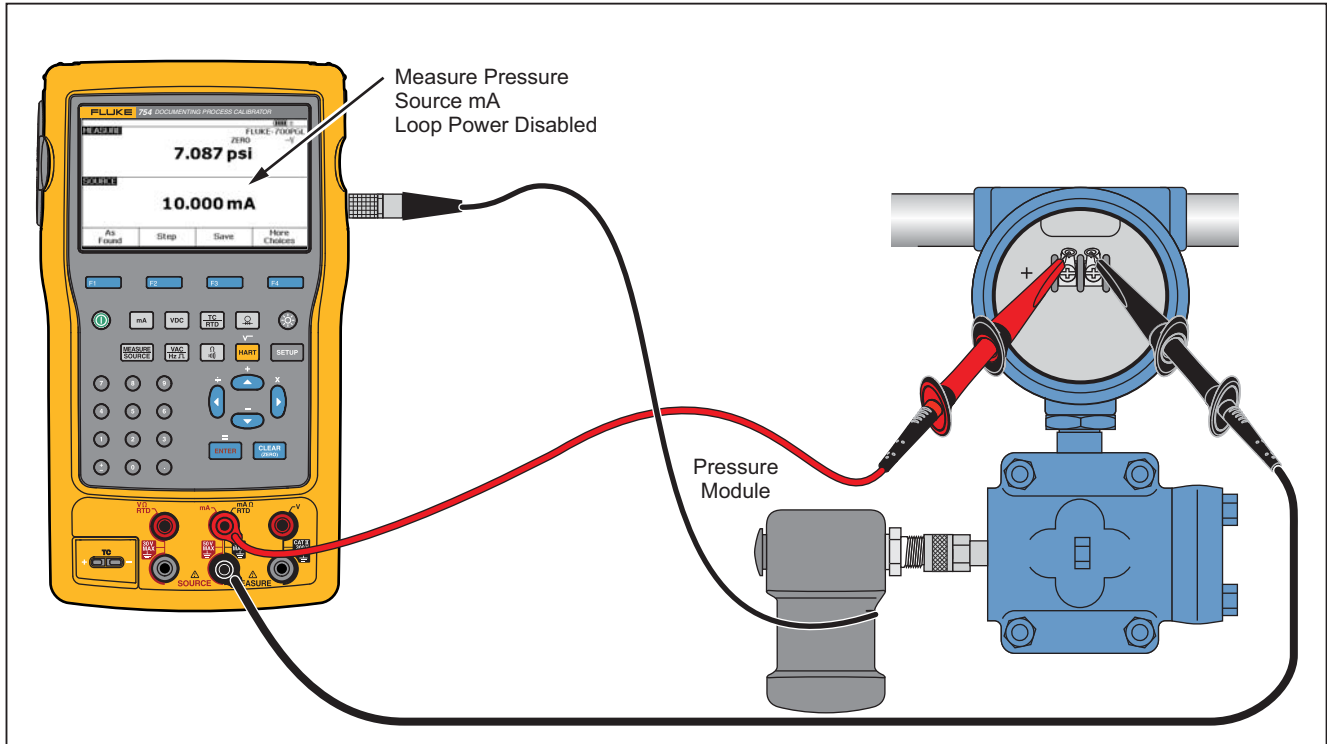

gks28c.eps

Figure 46. Current-to-Pressure (I/P) Transmitter Calibration

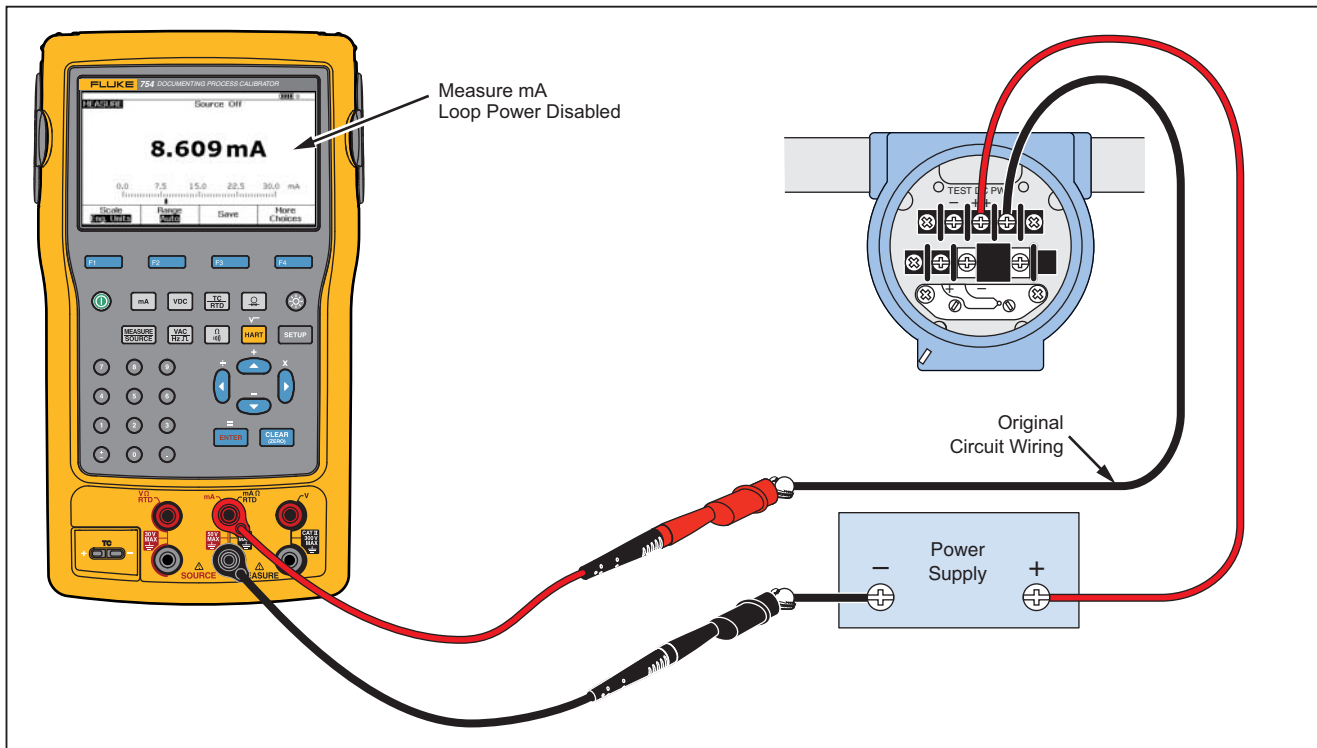

gks29c.eps

Figure 47. Output Current of a Transmitter Measurement

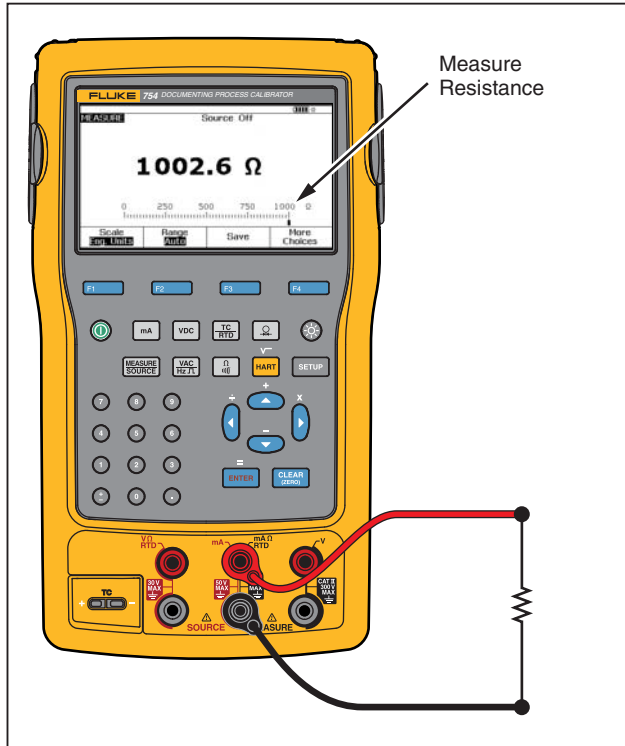

gks30c.eps

Figure 48. Precision Resistor Measurement

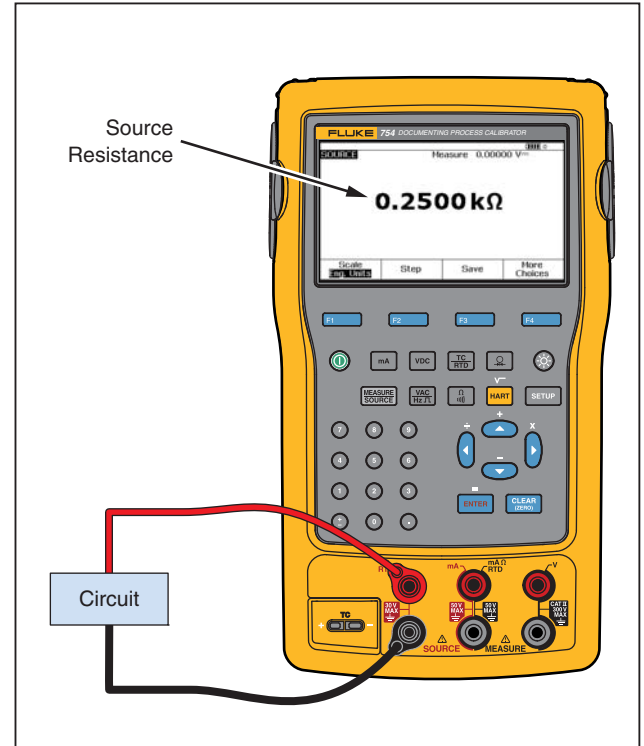

gks31c.eps

Figure 49. Resistance Source

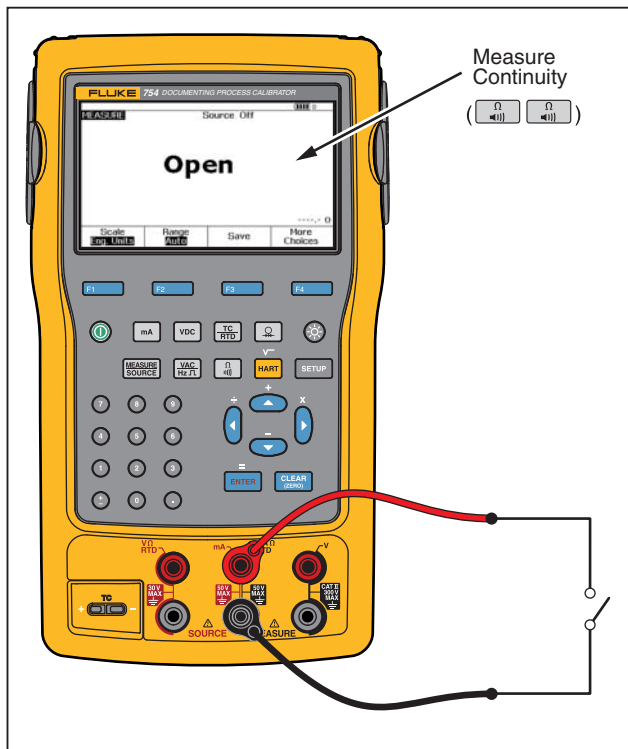

gks32c.eps

Figure 50. Checking a Switch

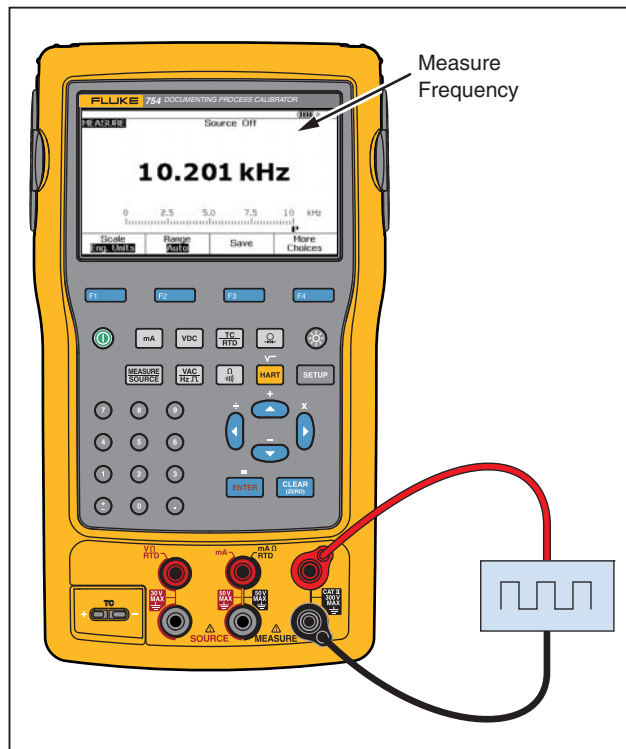

gks33c.eps

Figure 51. Tachometer Examination

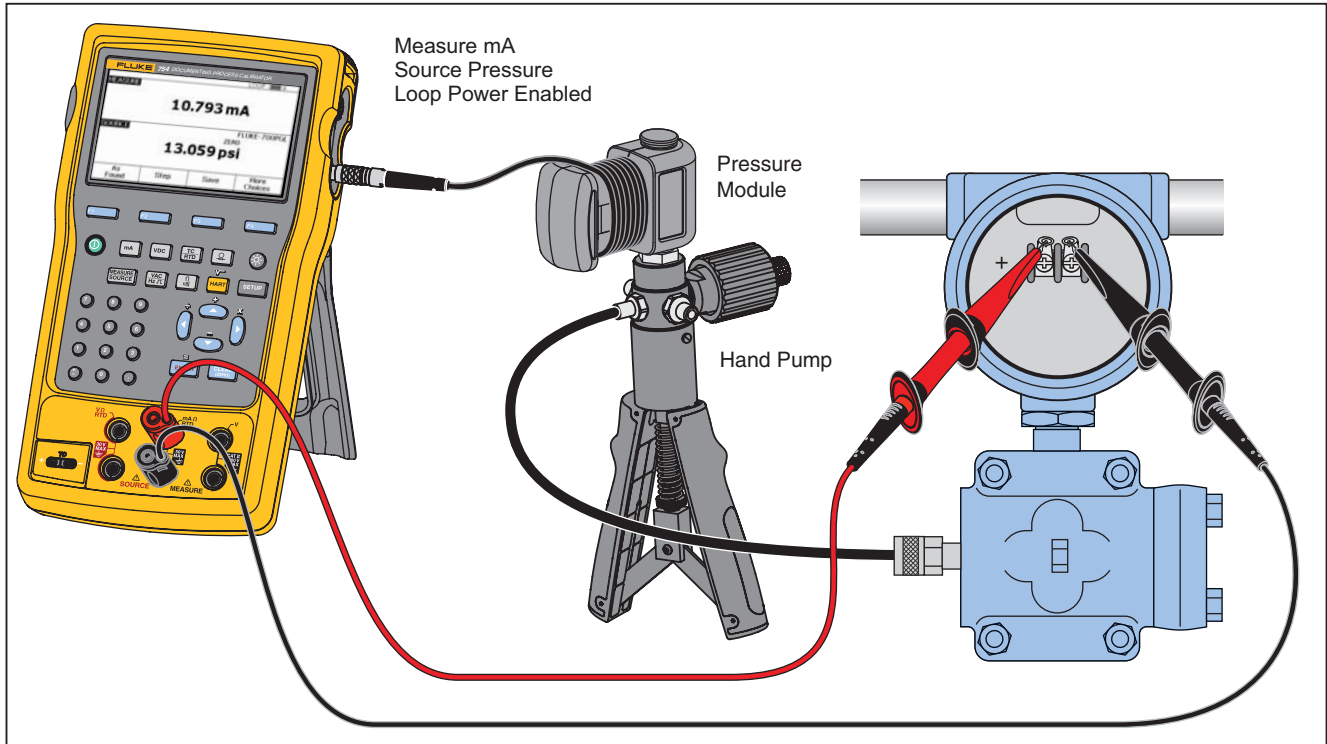

gks34c.eps

Figure 52. Analog and HART Pressure Transmitter Connection

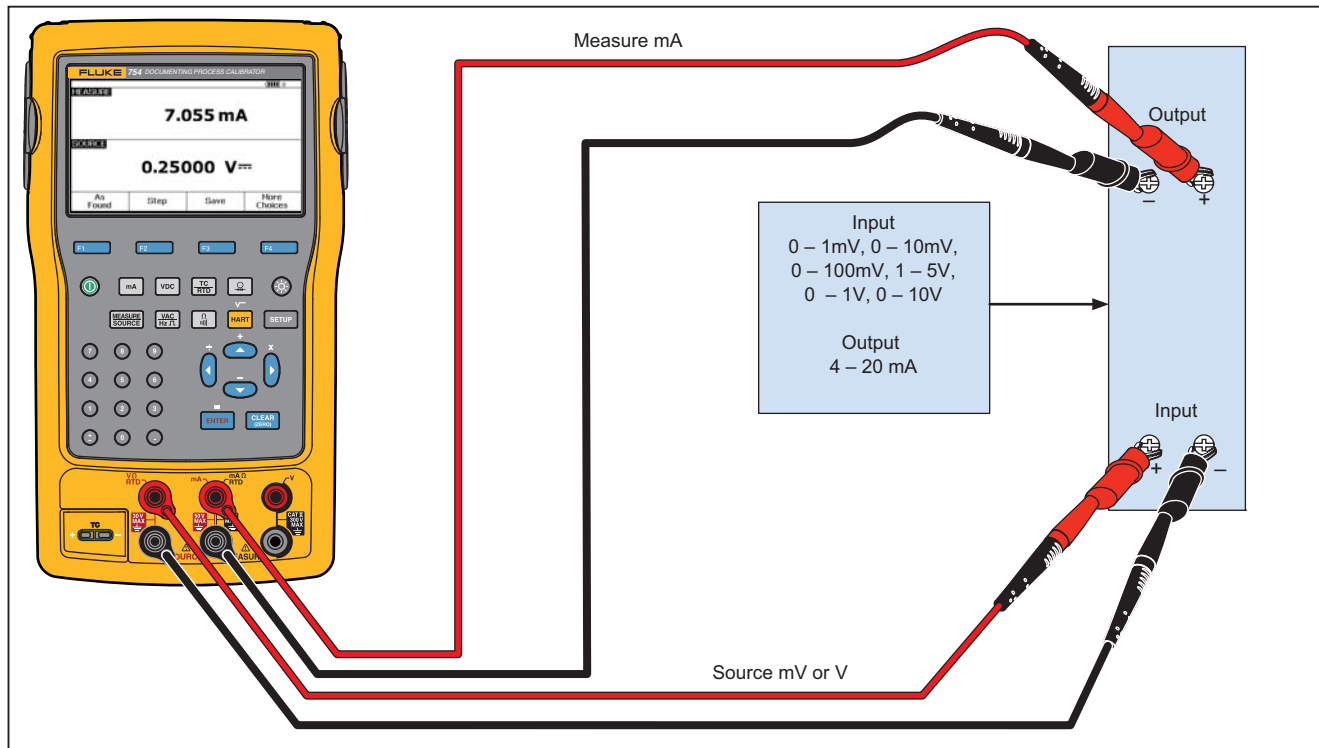

gks35c.eps

Figure 53. mV to Current Transmitter Calibration

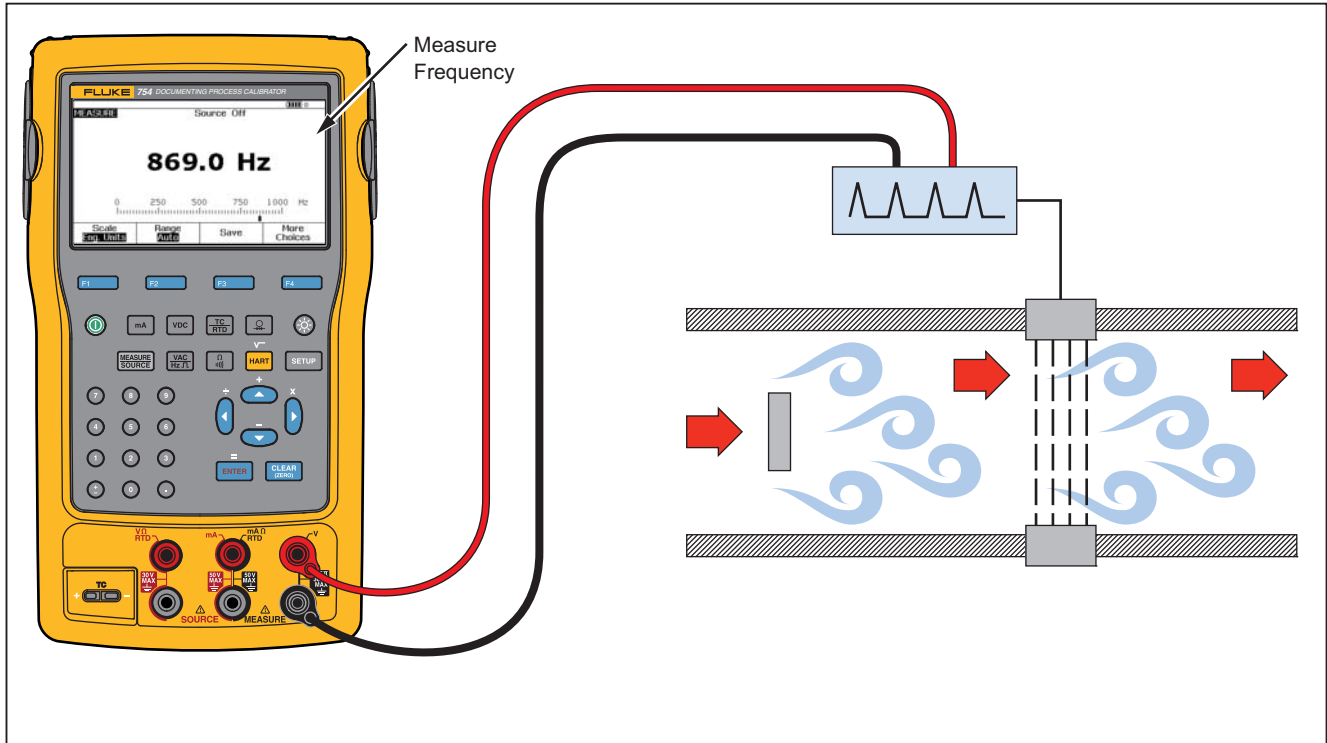

gks36c.eps

Figure 54. Vortex Shedding Flowmeter Check

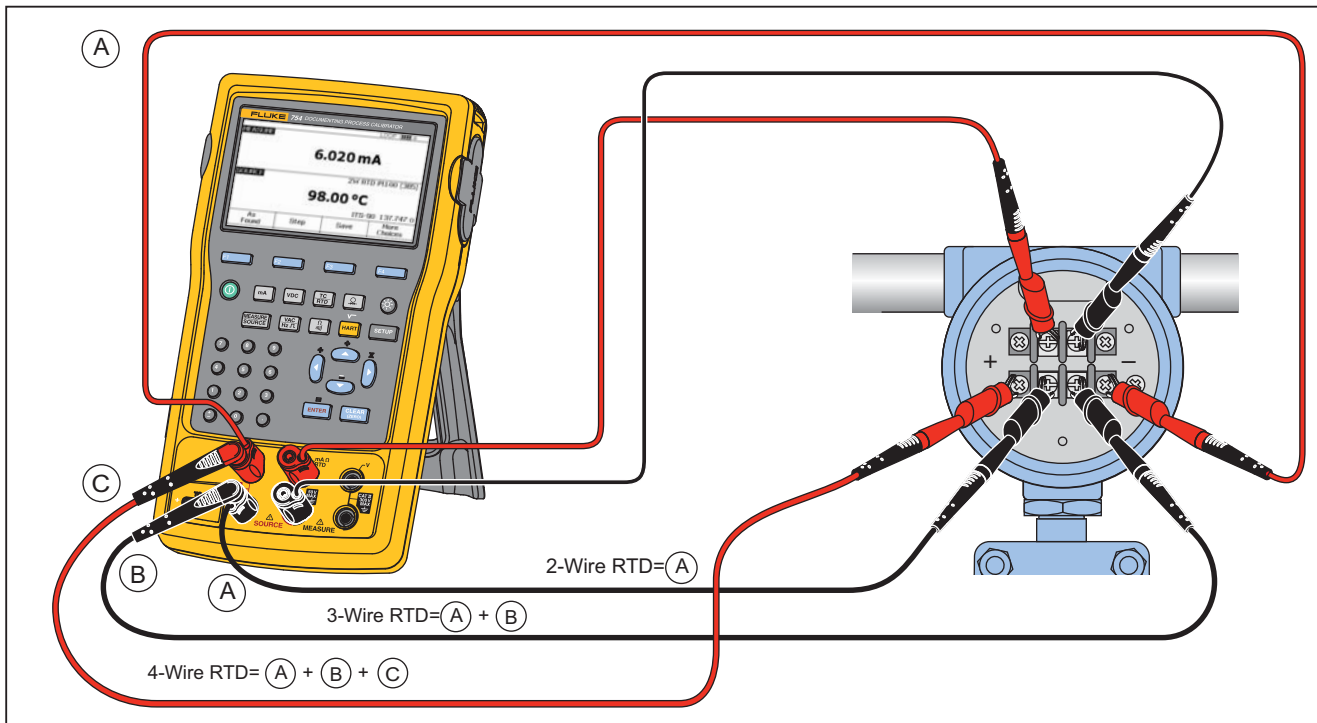

gks60.eps

Figure 55. HART and Analog RTD Transmitter Connections

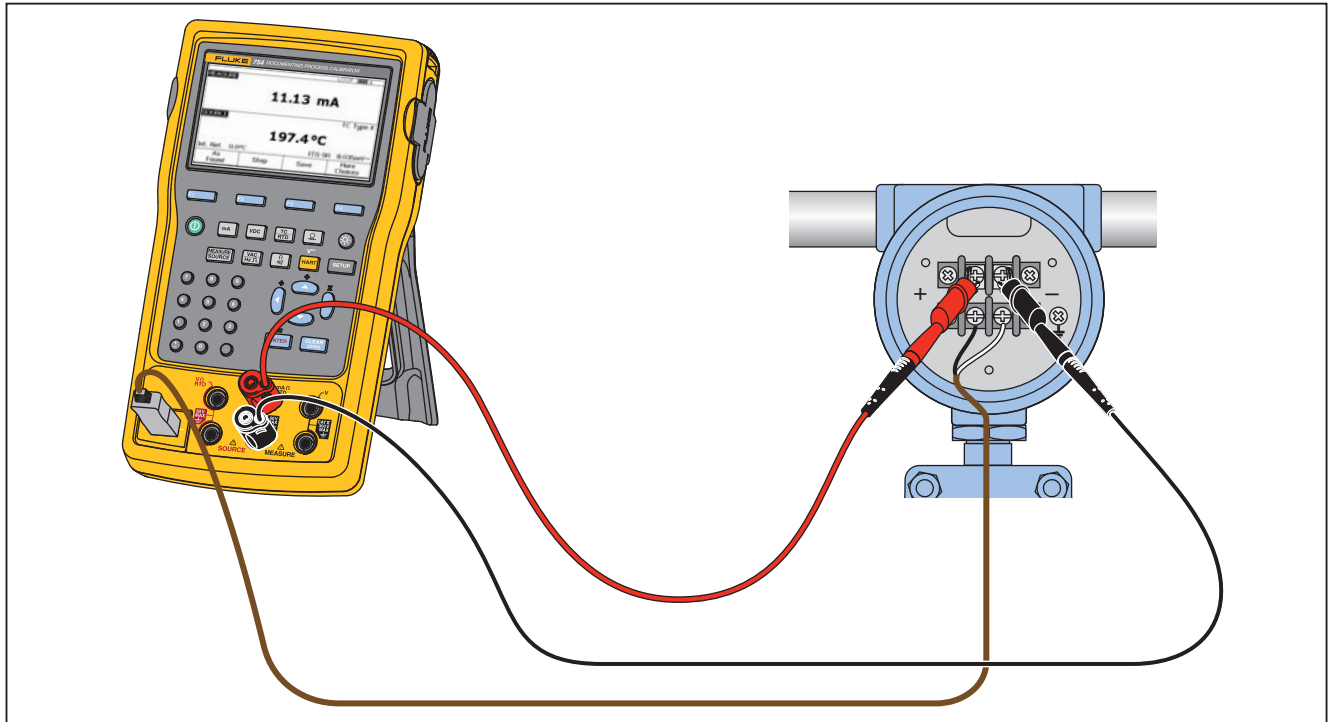

gks61.eps

Figure 56. Analog and HART Thermocouple Transmitter Connections

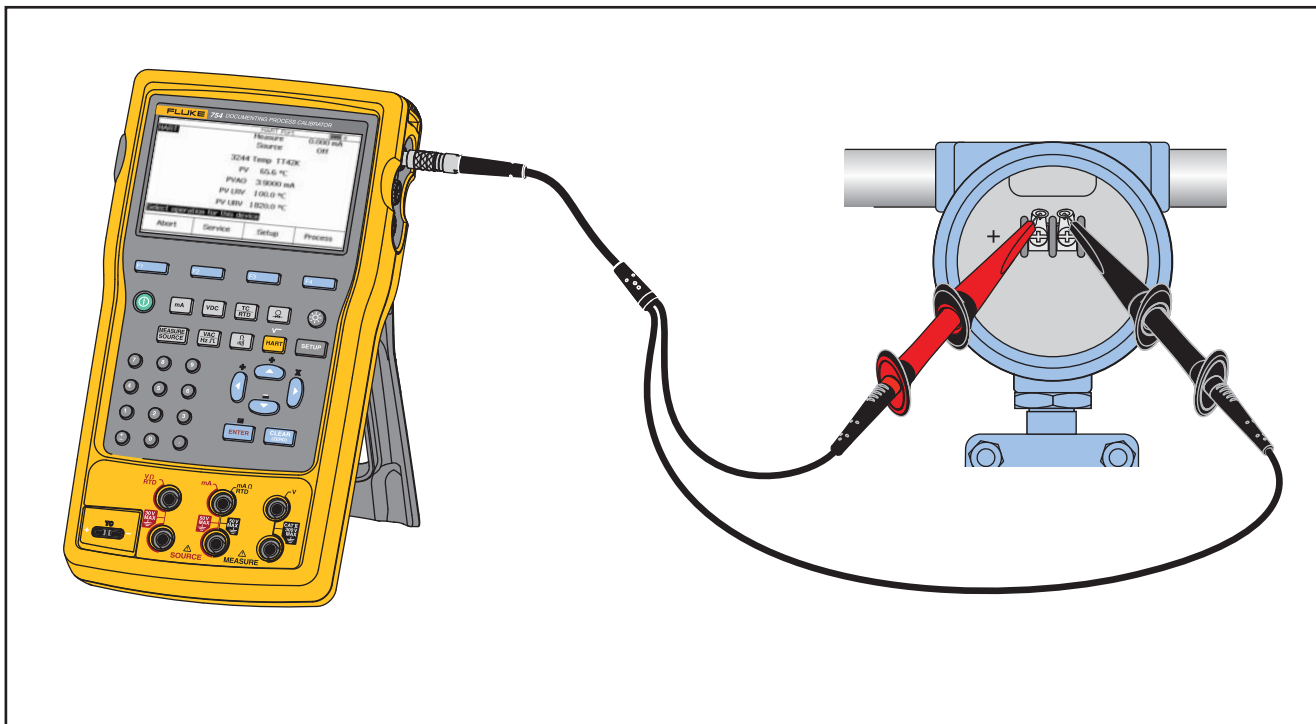

gks43.eps

Figure 57. Transmitter HART- Comm Only

Communication with a PC

Procedures and results that you have kept can be uploaded from and downloaded to a PC. A PC, Microsoft Windows, USB cable (supplied), and Fluke *DPCTrack2™* application software, or a qualified Fluke partner's software are required. See the *DPCTrack2 Users Manual* for further instructions.

Maintenance

⚠⚠ Warning

To prevent possible electrical shock, fire, or personal injury:

- **Have an approved technician repair the Product.**
- **Do not operate the Product with covers removed or the case open. Hazardous voltage exposure is possible.**
- **Remove the input signals before you clean the Product.**
- **Use only specified replacement parts.**

Note

Additional maintenance instructions, including a calibration procedure and a list of replaceable parts is available in the 75X Series Calibration Manual available from the Fluke website.

Battery Replacement

Replace the battery when it no longer holds a charge for the rated interval. The battery normally lasts for up to 300 charge/discharge cycles. To order a replacement battery, see "Contacting Fluke" and "User-Replaceable Parts".

Note

Spent batteries should be disposed of by a qualified recycler or hazardous materials handler. Contact an authorized Fluke Service Center for recycling information.

Clean the Product

Clean the Product and pressure modules with a soft cloth dampened with water or water and mild soap.

⚠ Caution

To prevent possible damage to the Product, do not use solvents or abrasive cleansers.

Calibration Data

The date of the last calibration and verification shows on the calibration sticker and on the calibration screen in Setup mode. The CAL. STATUS number on the sticker should always match the Calibration Status number in the calibration screen. Calibration of the Product is to be done by qualified personnel. See the *75X Series Calibration Manual* available at the Fluke website.

In Case of Difficulty

Warning

To avoid possible electric shock or personal injury, do not use the Product if it operates abnormally. Protection may be impaired. When in doubt, have the Product serviced.

If the display is blank or unreadable, but the beeper works when the Product is turned on, make sure the brightness is correctly adjusted. To adjust the Intensity, see “Display Intensity”.

If the Product will not turn on, make sure the battery is not dead or disconnected from the battery charger. If the Product receives power, the power button should be lit. If the button is lit, but the Product does not power up, have the Product serviced. See “How to Contact Fluke”.

Service Center Calibration or Repair

Calibration, repairs, or servicing not included in this manual must be done only by qualified service personnel. If the Product fails, examine the battery pack first, and replace it if necessary.

Make sure that you operate the Product in accordance with the instructions in this manual. If the Product is faulty, send a description of the failure with the Product. Pressure modules do not need to accompany the Product unless the module is faulty also. Be sure to pack the Product securely, using the original shipping container if it is available. See “How to Contact Fluke” and the Warranty Statement.

User-Replaceable Parts

Table 12 lists the Fluke part number of each user-replaceable part for the Product. See “Standard Equipment” and “Accessories” for model or part numbers of standard and optional equipment.

Table 12. Replacement Parts

Item	Fluke Part Number
Adjustable Quick-Release Strap	3889532
Input/Output Jack Decal	3405856
Tilt Stand	3404790
BP7240 Battery	4022220
USB Cable	1671807
BC7240 Power Supply/Battery Charger	4022655
Lens Cover	3609579
Alligator Clip Set-Extended Tooth	3765923
754HCC HART Communication Cable Assembly	3829410
AC280 Suregrip Hook Clip Set	1610115
TC Cap	4073631
<i>Note: See "Standard Equipment" and "Accessories" for model or part numbers for most replaceable equipment.</i>	

Accessories

The Fluke accessories listed below are compatible with the Product. For more information about these accessories and their prices, contact a Fluke representative.

- 700-IV Current Shunt
- *DPCTrack2* software
- C799 Soft Carry Case
- BC7240 Replacement Battery Charger/Universal Power Supply
- HART Drywell Cable Accessory (PN 2111088)
- 12-V Car Battery Charger
- Fluke-700PCK Pressure Module Calibration Kit (requires pressure calibration equipment and a PC compatible computer)
- 700PTP-1 Pneumatic test pump
- 700HTP-1 Hydraulic test pump
- Fluke-700TC1 TC miniplug kit
- Fluke-700TC2 TC miniplug kit
- C781 Soft Carrying Case
- C700 Hard Carrying Case
- BP7240 Li-Ion Battery
- TL series test leads
- AC series test lead clips
- TP series test lead probes
- 80PK series thermocouples
- Pressure Modules Fluke model numbers listed below. (Differential models also operate in gage mode.) Contact a Fluke representative about pressure modules not listed here.
 - FLUKE-700P00 1 in. H2O/0.001
 - FLUKE-700P01 10 in. H2O/0.01
 - FLUKE-700P02 1 psi/0.0001
 - FLUKE-700P22 1 psi/0.0001
 - FLUKE-700P03 5 psi/0.0001
 - FLUKE-700P23 5 psi/0.0001
 - FLUKE-700P04 15 psi/0.001
 - FLUKE-700P24 15 psi/0.001
 - FLUKE-700P05 30 psi/0.001
 - FLUKE-700P06 100 psi/0.01

- FLUKE-700P27 300 psi / 0.01
- FLUKE-700P07 500 psi/0.01
- FLUKE-700P08 1000 psi/0.1
- FLUKE-700P09 1500 psi/0.1
- FLUKE-700PA3 5 psi/0.0001
- FLUKE-700PA4 15 psi/0.001
- FLUKE-700PA5 30 psi/0.001
- FLUKE-700PA6 100 psi/0.01
- FLUKE-700PV3 -5 psi/0.0001
- FLUKE-700PV4 -15 psi/0.001
- FLUKE-700PD2 ± 1 psi/0.0001
- FLUKE-700PD3 ± 5 psi/0.0001
- FLUKE-700PD4 ± 15 psi/0.001
- FLUKE-700PD5 -15/30 psi/0.001
- FLUKE-700PD6 -15/100 psi/0.01
- FLUKE-700PD7 -15/200 psi/0.01
- FLUKE-700P29 3000 psi/0.1
- FLUKE-700P30 5000 psi/0.1
- FLUKE-700P31 10000 psi/1

Specifications

General Specifications

All specifications apply from +18 °C to +28 °C unless stated otherwise.

All specifications assume a 5-minute warmup period.

Measurement specifications are valid only when Damping is turned on. When damping is turned off, or when the  annunciator is shown, floor specifications are multiplied by 3. Floor specifications are the second part of the specifications. The measure pressure, temperature, and frequency functions are specified only with damping on.

Specifications are valid to 110 % of range. The following exceptions are valid to 100 % of range: 300 V dc, 300 V ac, 22 mA source and simulate, 15 V dc source, and temperature measure and source.

To achieve the best noise rejection, use battery power.

Size (H x W x L) Height = 63.35 mm (2.49 inches) x Width = 136.37 mm (5.37 inches)
x Length = 244.96 mm (9.65 inches)

Weight 1.23 kg (2.71 lb) (Batteries included)

Display 480 by 272 pixel graphic LCD, 95 x 54 mm

Power Internal battery pack: Lithium Ion, 7.2 V dc, 30 Wh

Environmental Specifications

Operating Altitude 3000 m (9842 ft)

Storage Altitude 13000 m (42650 ft)

Operating Temperature -10 to 50 °C

Storage Temperature -20 to 60 °C

Relative Humidity (Maximum, non-condensing) 90 % to 35 °C

75 % to 40 °C

45 % to 50 °C

Standards and Agency Approval Specifications

Protection Class Pollution Degree II IP 52

Double Insulation Creepage and Clearance Per IEC 61010-1
Installation Category 300 V CAT II
Design Standards and Compliance EN/IEC 61010-1:2010, CAN/CSA C22.2 No. 61010-1-04, ANSI/UL 61010-1:2004
EMI, RFI, EMC EN 61326-1:2006
RF Fields Accuracy for all functions is not specified in RF fields >3 V/m

Detailed Specifications

Specifications valid after a 5-minute warmup.

Specifications are valid to 110 % of Range with the following exceptions: 300 V dc measure, 300 V ac measure, 50 kHz measure and source, 22 mA source and simulate, 15 V dc source, and temperature measure and source which are valid to 100 % of range.

DC mV Measurement

Range	Resolution	% of Reading + Floor	
		1 Year	2 Year
±100.000 mV	0.001 mV	0.02 % + 0.005 mV	0.03 % + 0.005 mV
Input Impedance: >5 MΩ Maximum Input Voltage: 300 V, IEC 61010 300 V CAT II Temperature coefficient: (0.001 % of reading + 0.001% of range) / °C (<18 °C or >28 °C) Normal mode rejection: >100 dB at 50 or 60 Hz nominal			

DC Voltage Measurement

Range	Resolution	% of Reading + Floor	
		1 Year	2 Year
±3.00000 V	0.00001 V	0.02 % + 0.00005 V	0.03 % + 0.00005 V
±30.0000 V	0.0001 V	0.02 % + 0.0005 V	0.03 % + 0.0005 V
±300.00 V	0.01 V	0.05 % + 0.05 V	0.07 % + 0.05 V

Input Impedance: >4 MΩ
Maximum Input Voltage: 300 V, IEC 61010 300V CAT II
Temperature coefficient: (0.001 % of reading + 0.0002 % of range) / °C (<18 °C or >28 °C)
Normal mode rejection: >100 dB at 50 or 60 Hz nominal

AC Voltage Measurement

Range 40 Hz – 500 Hz	Resolution	% of Reading + Floor	
		1 Year	2 Year
3.000 V	0.001 V	0.5 % + 0.002 V	1.0 % + 0.004 V
30.00 V	0.01 V	0.5 % + 0.02 V	1.0 % + 0.04 V
300.0 V	0.1 V	0.5 % + 0.2 V	1.0 % + 0.2 V

Input Impedance: >4 MΩ and <100 pF
Input Coupling: AC
Maximum Input Voltage: 300 V, IEC 61010 300V CAT II
Temperature coefficient: 5 % of specified accuracy / °C (<18 °C or >28 °C)
Specifications apply for 9 % to 100 % of voltage range.

DC Current Measurement

Range	Resolution	% of Reading + Floor	
		1 Year	2 Year
±30.000 mA	1 µA	0.01 % + 5 µA	0.015 % + 7 µA
±100.00 mA	10 µA	0.01 % + 20 µA	0.015 % + 30 µA
Maximum Input: 110 mA Maximum Burden Voltage: 420 mV at 22 mA Temperature coefficient: 3 % of specified accuracy / °C (<18 °C or >28 °C) No Fuse Normal mode rejection: 90 dB at 50 or 60 Hz nominal, and 60 dB at 1200 Hz and 2200 Hz nominal (HART signals)			

Resistance Measurement

Range	Resolution	% of Reading + Floor		Source Current
		1 Year	2 Year	
10.000 Ω	0.001 Ω	0.05 % + 0.050 Ω	0.07 % + 0.070 Ω	3 mA
100.00 Ω	0.01 Ω	0.05 % + 0.05 Ω	0.07 % + 0.07 Ω	1 mA
1.0000 kΩ	0.1 Ω	0.05 % + 0.0005 kΩ	0.07 % + 0.0007 kΩ	500 µA
10.000 kΩ	1 Ω	0.10 % + 0.010 kΩ	0.15 % + 0.015 kΩ	50 µA
Open-circuit voltage: 5 V nominal Temperature coefficient: 3 % of specified accuracy / °C (<18 °C or >28 °C)				

Continuity Testing

Tone	Resistance
Continuous tone	<25 Ω
May or may not get tone	25 to 400 Ω
No tone	>400 Ω

Frequency Measurement

Ranges	Resolution	2 Year
1.00 Hz to 110.00 Hz ^[1]	0.01 Hz	0.05 Hz
110.1 Hz to 1100.0 Hz	0.1 Hz	0.5 Hz
1.101 kHz to 11.000 kHz	0.001 kHz	0.005 kHz
11.01 kHz to 50.00 kHz	0.01 kHz	0.05 kHz

Coupling: AC
 Minimum Amplitude for Frequency Measurement (square wave):
 <1 kHz: 300 mV p-p
 1 kHz to 30 kHz: 1.4 V p-p
 >30 kHz: 2.8 V p-p
 Maximum input:
 <1 kHz: 300 V rms
 >1 kHz: 30 V rms
 Input Impedance: >4 MΩ
 [1] For frequency measurement less than 110.00 Hz, specifications apply for signals with a slew rate >5 volt/millisecond.

±DC Voltage Output

Range	Resolution	% of Output + Floor	
		1 Year	2 Year
±100.000 mV	1 μV	0.01 % + 0.005 mV	0.015 % + 0.005 mV
±1.00000 V	10 μV	0.01 % + 0.00005 V	0.015 % + 0.00005 V
±15.0000 V	100 μV	0.01 % + 0.0005 V	0.015 % + 0.0005 V

Maximum Output Current: 10 mA, In the 100 mV range add 0.010 mV to specification when sourcing >1 mA.
 For sourcing dc voltages <110.000 mV, accuracy is not specified in RF fields >1 V/m, 80 MHz to 700 MHz.
 Temperature Coefficient: 0.001 % of output + 0.001 % of range / °C (<18 °C or >28 °C)

+DC Current Source

Range/Mode	Resolution	% of Output + Floor	
		1 Year	2 Year
0.100 to 22.000 mA	1 μ A	0.01 % + 3 μ A	0.02 % + 3 μ A
Temperature Coefficient: 3 % of specified accuracy / °C (<18 °C or >28 °C) Source mA Compliance Voltage: 18 V maximum Source mA Open Circuit Voltage: 30 V maximum			

+DC Current Simulate (External Loop Power)

Range/Mode	Resolution	% of Output + Floor	
		1 Year	2 Year
0.100 to 22.000 mA (Current Sink)	1 μ A	0.02 % + 7 μ A	0.04 % + 7 μ A
Simulate mA Input Voltage: 15 to 50 V dc, add 300 μ A to floor when >25 V is present on the loop Temperature Coefficient: 3 % of specified accuracy / °C (<18 °C or >28 °C)			

Resistance Sourcing

Range	Resolution	% of Output + Floor		Allowable Excitation Current
		1 Year	2 Year	
10.000 Ω	0.001 Ω	0.01 % + 0.010 Ω	0.015 % + 0.015 Ω	0.1 mA to 10 mA
100.00 Ω ^[1]	0.01 Ω	0.01 % + 0.02 Ω	0.015 % + 0.03 Ω	0.1 mA to 10 mA
1.0000 k Ω ^[2]	0.1 Ω	0.02 % + 0.0002 k Ω	0.03 % + 0.0003 k Ω	0.01 mA to 1.0 mA
10.000 k Ω	1 Ω	0.02 % + 0.003 k Ω	0.03 % + 0.005 k Ω	0.01 mA to 1.0 mA
Temperature Coefficient: (0.01 % of output +0.02 % of range / °C (<18 °C or >28 °C). When connected to mains, accuracy is not specified with conducted RF >1V, 8 to 15 MHz. [1] Add 0.01 Ω when the excitation current is <1 mA. [2] Add 0.0015 k Ω when the excitation current is <0.1 mA.				

Frequency Sourcing

Range	Specification
	2 Year
Sine Wave: 0.1 Hz to 10.99 Hz	0.01 Hz
Square Wave: 0.01 Hz to 10.99 Hz	0.01 Hz
Sine and Square Wave: 11.00 Hz to 109.99 Hz	0.1 Hz
Sine and Square Wave: 110.0 Hz to 1099.9 Hz	0.1 Hz
Sine and Square Wave: 1.100 kHz to 21.999 kHz	0.002 kHz
Sine and Square Wave: 22.000 kHz to 50.000 kHz	0.005 kHz
Waveform Choices: Zero-symmetric sine wave or positive 50 % duty-cycle square wave Square Wave Amplitude: 0.1 to 15 V p-p Square Wave Amplitude Accuracy, 0.01 to 1 kHz: 3 % p-p output + 75 mV, 1 kHz to 50 kHz: 10 % p-p output + 75 mV typical. Sine Wave Amplitude: 0.1 to 30 V p-p Sine Wave Amplitude Accuracy, 0.1 to 1 kHz: 3 % p-p output + 75 mV, 1 kHz to 50 kHz: 10 % p-p output + 75 mV typical. Frequency specifications are valid when averaged ≥ 100 ms	

Temperature, Thermocouples

Type	Range °C	Measure °C		Source °C	
		1 Year	2 Year	1 Year	2 Year
E	-250 to -200	1.3	2.0	0.6	0.9
	-200 to -100	0.5	0.8	0.3	0.4
	-100 to 600	0.3	0.4	0.3	0.4
	600 to 1000	0.4	0.6	0.2	0.3
N	-200 to -100	1.0	1.5	0.6	0.9
	-100 to 900	0.5	0.8	0.5	0.8
	900 to 1300	0.6	0.9	0.3	0.4
J	-210 to -100	0.6	0.9	0.3	0.4
	-100 to 800	0.3	0.4	0.2	0.3
	800 to 1200	0.5	0.8	0.3	0.3
K	-200 to -100	0.7	1.0	0.4	0.6
	-100 to 400	0.3	0.4	0.3	0.4
	400 to 1200	0.5	0.8	0.3	0.4
	1200 to 1372	0.7	1.0	0.3	0.4
T	-250 to -200	1.7	2.5	0.9	1.4
	-200 to 0	0.6	0.9	0.4	0.6
	0 to 400	0.3	0.4	0.3	0.4
B	600 to 800	1.3	2.0	1.0	1.5
	800 to 1000	1.0	1.5	0.8	1.2
	1000 to 1820	0.9	1.3	0.8	1.2

Type	Range °C	Measure °C		Source °C	
		1 Year	2 Year	1 Year	2 Year
R	-20 to 0	2.3	2.8	1.2	1.8
	0 to 100	1.5	2.2	1.1	1.7
	100 to 1767	1.0	1.5	0.9	1.4
S	-20 to 0	2.3	2.8	1.2	1.8
	0 to 200	1.5	2.1	1.1	1.7
	200 to 1400	0.9	1.4	0.9	1.4
	1400 to 1767	1.1	1.7	1.0	1.5
C (W5Re/W26Re)	0 to 800	0.6	0.9	0.6	0.9
	800 to 1200	0.8	1.2	0.7	1.0
	1200 to 1800	1.1	1.6	0.9	1.4
	1800 to 2316	2.0	3.0	1.3	2.0
L	-200 to -100	0.6	0.9	0.3	0.4
	-100 to 800	0.3	0.4	0.2	0.3
	800 to 900	0.5	0.8	0.2	0.3
U	-200 to 0	0.6	0.9	0.4	0.6
	0 to 600	0.3	0.4	0.3	0.4
BP	0 to 1000	1.0	1.5	0.4	0.6
	1000 to 2000	1.6	2.4	0.6	0.9
	2000 to 2500	2.0	3.0	0.8	1.2

Documenting Process Calibrator Detailed Specifications

Type	Range °C	Measure °C		Source °C	
		1 Year	2 Year	1 Year	2 Year
XK	-200 to 300	0.2	0.3	0.2	0.5
	300 to 800	0.4	0.6	0.3	0.6

Sensor inaccuracies not included.

Accuracy with external cold junction; for internal junction add 0.2 °C

Resolution: 0.1 °C

Temperature Scale: ITS-90 or IPTS-68, selectable (90 is default)

Compensation: ITS-90 per NIST Monograph 175 for B,R,S,E,J,K,N,T; IPTS-68 per IEC 584-1 for B,R,S,E,J,K,T; IPTS-68 per DIN 43710 for L,U. GOST P 8.585-2001 (Russia) for BP and XK, ASTM E988-96 for C (W5Re/W26Re)

Temperature Coefficient: 0.05 °C/ °C (<18 °C or >28 °C)

0.07 °C/ °C for C type >1800 °C and for BP type >2000 °C

Instrument Operating Temperature: 0 to 50 °C for C and BP type thermocouples / -10 to 50 °C for all other types

Normal Mode Rejection: 65 dB at 50 Hz or 60 Hz nominal

For sourcing thermocouple voltages, accuracy is not specified in RF fields >1 V/m, 80 MHz to 700 MHz.

Temperature, Resistance Temperature Detectors

Temperature, RTDs Degrees or % of Reading ^[1]							
Type (α)	Range °C	Measure °C ^[2]			Source °C		Allowable Excitation Current ^[3]
		1 Year	2 Year	Source Current	1 Year	2 Year	
100 Ω Pt(385)	-200 to 100	0.07 °C	0.14 °C	1 mA	0.05 °C	0.10 °C	0.1 to 10 mA
	100 to 800	0.02 % + 0.05 °C	0.04 % + 0.10 °C		0.0125 % + 0.04 °C	0.025 % + 0.08 °C	
200 Ω Pt(385)	-200 to 100	0.07 °C	0.14 °C	500 μ A	0.10 °C	0.20 °C	0.1 to 1 mA
	100 to 630	0.02 % + 0.05 °C	0.04 % + 0.10 °C		0.017 % + 0.09 °C	0.034 % + 0.18 °C	
500 Ω Pt(385)	-200 to 100	0.07 °C	0.14 °C	250 μ A	0.08 °C	0.16 °C	0.1 to 1 mA
	100 to 630	0.02 % + 0.05 °C	0.04 % + 0.10 °C		0.017 % + 0.06 °C	0.034 % + 0.12 °C	
1000 Ω Pt(385)	-200 to 100	0.07 °C	0.14 °C	150 μ A	0.06 °C	0.12 °C	0.1 to 1 mA
	100 to 630	0.02 % + 0.05 °C	0.04 % + 0.10 °C		0.017 % + 0.05 °C	0.034 % + 0.10 °C	
100 Ω Pt(3916)	-200 to 100	0.07 °C	0.14 °C	1 mA	0.05 °C	0.10 °C	0.1 to 10 mA
	100 to 630	0.02 % + 0.05 °C	0.04 % + 0.10 °C		0.0125 % + 0.04 °C	0.025 % + 0.08 °C	
100 Ω Pt(3926)	-200 to 100	0.08 °C	0.16 °C	1 mA	0.05 °C	0.10 °C	0.1 to 10 mA
	100 to 630	0.02 % + 0.06 °C	0.04 % + 0.12 °C		0.0125 % + 0.04 °C	0.025 % + 0.08 °C	

Temperature, RTDs Degrees or % of Reading ^[1]							
Type (α)	Range °C	Measure °C ^[2]			Source °C		Allowable Excitation Current ^[3]
		1 Year	2 Year	Source Current	1 Year	2 Year	
10 Ω Cu(427)	-100 to 260	0.2 °C	0.4 °C	3 mA	0.2 °C	0.4 °C	1 to 10 mA
120 Ω Ni(672)	-80 to 260	0.1 °C	0.2 °C	1 mA	0.04 °C	0.08 °C	0.1 to 10 mA
<p>[1] Specifications are valid to k=3 Sensor inaccuracies not included</p> <p>[2] For two and three-wire RTD measurements, add 0.4 °C to the specifications. Resolution: 0.01 °C except 0.1 °C for 10 Ω Cu(427) Temperature Coefficient: 0.01 °C/°C for measure, 0.02 °C/°C (<18 °C or >28 °C) for source</p> <p>[3] Supports pulsed transmitters and PLCs with pulse times as short as 1 ms RTD Reference: Pt(385): IEC 60751, 2008 Pt(3916): JIS C 1604, 1981 Pt(3926), Cu(427), Ni(672): Minco Application Aid #18</p>							

Loop Power

Open Circuit	Loaded Circuit
26 V \pm 10 %	18 V minimum at 22 mA
Short circuit protected to 25 mA Output Resistance: 250 Ω nominal	

