

UT377A Mini Wood Moisture Meter User Manual

I. Introduction

UT377A is a stable, safe and reliable wood moisture meter.

Features:

- Wood type selection
- Temperature compensation
- Power saving
- High accuracy
- Quick response
- Wide scope of application: raw material, papermaking, furniture, etc.

Warning: For safety and accuracy, please read this manual before use.

II. Open Box Inspection

Open the packing box and take out the meter. Please check if the following items are deficient or damaged. Please contact your supplier immediately if any item is deficient or damaged.

1. Plastic holder-----1 set
2. User Manual-----1 pcs
3. Battery 1.5V AAA-----3 pcs

III. Safety instructions

Warning:

To avoid injury, keep this meter unaccessible to the minor.

The meter complies with standards: GB/T1931-2009 and JJG 986-2004

1. Before use, inspect the meter for any damage. Pay particular attention to the insulation layer and the display screen. Do not use the meter if it is not working properly.
2. Follow the operation instructions.
3. Do not change the internal circuit of the meter.
4. When low power symbol  appears, please replace the battery. If the meter is not used for a long time, please remove the battery.
5. Do not use or store the meter in the environments of high temperature, high humidity, flammable, explosive and strong magnetic field environments.
6. Please use soft cloth and detergent to clean the case. Do not use abrasant and solvent
7. The product has CE certification.

IV. Structure

- ① Sensor protection cover
- ② Probe cap
- ③ Measuring probes
- ④ Temperature sensor
- ⑤ Display screen
- ⑥ Functional buttons

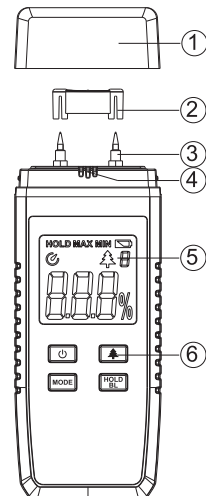

Figure 1

V. Symbols

- ① Auto power off
- ② Data hold
- ③ Maximum value
- ④ Minimum value
- ⑤ Low power
- ⑥ Wood symbol
- ⑦ Wood type
- ⑧ Measure unit

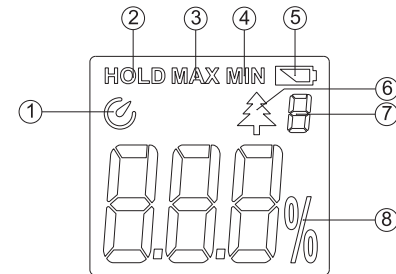



Figure 2

VI. Buttons and settings

1. : Power ON /OFF

- 1) Short press  to power ON.
- 2) Short press  again to power OFF

2. :Select wood type

Short press this button to cycle switch the wood types. (refer to table 2: wood types)
Default mode: type 3.

Notes:

Moisture content varies according to climate, geography, plant location, and even different parts of the same tree.

3. : select measurement modes

Short press: switch from MAX/MIN or regular measurement.

Long press this button to turn ON/OFF auto power OFF function,

 appears to indicate auto power off. Under this mode, the meter will automatically power off without any operation for about 5 mins.

4. :Data hold / Backlight

Short press to turn ON/OFF hold function. Long press to turn ON/OFF backlight.

VII. Operation instructions

1. Short press  to turn on the device

2. Press  button to select wood type.(Refer to VI- 2)

3. Take off the protection cover and probe cap. To avoid missing parts, insert the cap into the cover (see figure3)

- 4.Insert the probe vertically into the wood to be measured. The insert depth is shown as Figure 4.

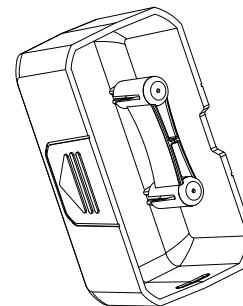

Figure 3

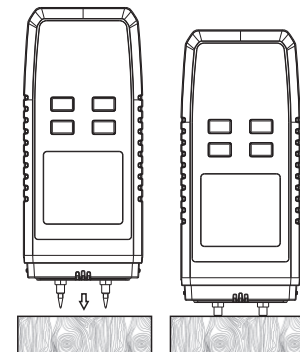



Figure 4

5. The reading is the absolute value of moisture content
6. Press  to measure maximum value or minimum value
7. Press  button to select backlight or data holding.
(Refer to VI- 4 for the detail)

Notes:

To avoid breaking the probe, please gently shake and loose it along the wood grain direction when pulling out the meter. (Figure 5)

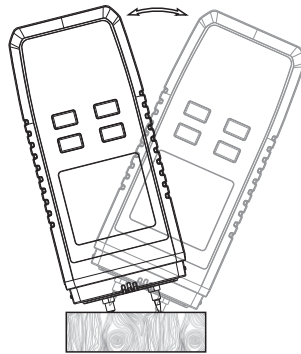



Figure 5

VIII. Performance specification

1. Technical specifications

Function	Range	Resolution	Accuracy	Remark
Moisture content	2.0~40.0%	0.1%	±2.0%	Type 1 : 2.0%~25.0% Type 2 : 3.0%~30.0% Type 3 : 4.0%~35.0% Type 4 : 5.0%~40.0%
Probe pull and plug	≥1000 times	/	/	Reliability test
Ambient temperature (calibration)	-10~60°C (14~140°F)	/	/	Correct the accuracy influenced by ambient temperature

2. General specifications

- a. LCD display, maximum display: 99.9.
- b. Low power symbol: 
- c. Update rate: 0.5 second
- d. Sensor type: resistance type sensor
- e. Drop test: 1 meter
- f. Battery :1.5 V AAA * 3
- g. Dimension: 136 mm *54 mm * 28 mm
- h. Weight : about 130 g

3. Operating environment

- a. Indoor use
- b. Altitude: 2000 meters (maximum)
- c. Pollution class: Level 2
- d. Operating temperature: 0°C~40°C (32~104°F)
- e. Operating humidity: ≤ 80% RH (-4~140°F)

4. Electric specifications

- a. Accuracy: ±2.0%
- b. Ambient temperature: 23°C ±5°C (64.4~82.4°F)
- c. Ambient humidity: 75% RH

5. General maintenance

Warning:

- To avoid false reading and injury, please do not open the meter cover.
- a. The maintenance and service of the meter must be implemented by qualified professional personnel or the designated departments.
 - b. Use dry cloth to clean the cover, do not use the detergent containing solvent and abradant.

6. Battery installation and Replacement

The meter uses three AAA 1.5V alkaline batteries for operation.

To install or replace the battery:

- a. Unscrew the battery cover, remove the cover and install new batteries ensuring that the correct polarity is observed.
- b. Use the batteries of the same type
- c. Replace the battery and screw up.

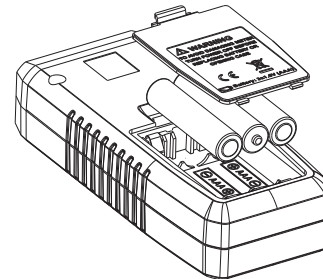

Figure 6

7. Wood types

Tree species	Wood type	Tree species	Wood type
Rhodes teak	1	Ash wood	3
White ormosia	1	Light wood	3
Brazil walnut tree	1	Sandalwood	3
Walnut	2	Elm	3
Cloning wood	2	Yunnan stone Catalpa	3
Poplar	2	Hemlock spruce	3
Teak	2	Gurjun	3
Fir wood	3	Birch	4
Douglas fir	3	Masson Pine	4
Lauan	3	Larch	4
Channel willow	3	Basswood	4
White fir	3	Chilean Pine	4
Oak	3	White pine	4
Acer mono	3	Ah East	4

UNI-T

UNI-TREND TECHNOLOGY (CHINA) LIMITED

Manufacturer:
No6, Gong Ye Bei 1st Road,
Songshan Lake National High-Tech Industrial
Development Zone, Dongguan City,
Guangdong Province, China
Tel: (86-769) 8572 3888
Fax: (86-769) 8572 5888
Postal Code: 523 808
<http://www.uni-trend.com>

Headquarters:
Rm 901,9/F,Nanyang Plaza,57 Hung To Road,
Kwun Tong, Kowloon,Hong Kong