

MASTECH[®]

MS6612

Multi-functional Light Meter USER MANUAL

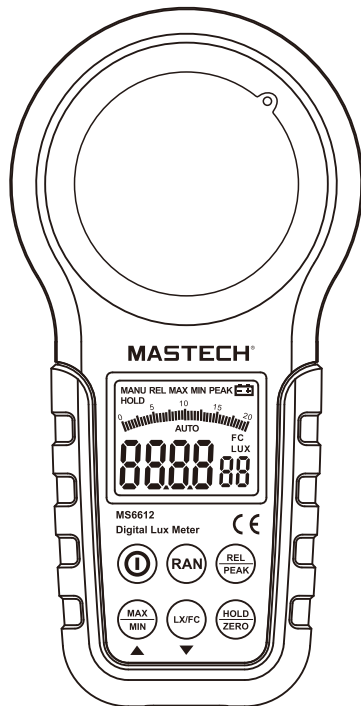

CONTENTS

INTRODUCTION.....	1
LIMITED WARRANTY, RIGHTS AND RESPONSIBILITIES...	2
OPEN-PACKAGE INSPECTION.....	2
SAFETY INFORMATION.....	4
1. INTRODUCTION.....	9
1.1 Product Description.....	9
1.2 Outstanding features of the ms6612 multi-function light meter.....	10
1.3 Name and function of components.....	11
1.3.1 Plan view.....	11
1.3.2 LCD display interface.....	13
2. MEASUREMENT METHODS.....	14
2.1 Notices prior to measurement.....	14
2.2 Action principles.....	15
2.2.1 Concepts of illuminance scales.....	15
2.2.2 Unit conversion for illuminance scales...	15

CONTENTS

2.2.3 Conversion formula for illuminance and light intensity.....	15
2.3 Typical practice cases.....	16
3. SPECIFIC APPLICATION.....	19
3.1 Application of manual switchover of range measurement mode.....	19
3.2 Application of relative/peak value measurement mode.....	21
3.3 Application of maximum/minimum value inquiry mode.....	22
3.4 Application of data hold and zero calibration mode.....	23
4. OTHER FUNCTIONS.....	25
4.1 AUTO POWER-OFF.....	25
4.2 MUTE.....	25
5. TECHNICAL DATA.....	26
6. MAINTENANCE AND SERVICE.....	28
6.1 SERVICE.....	28
6.2 CLEANING.....	28
6.3 BATTERY REPLACEMENT.....	29
6.4 CALIBRATION INTERVAL.....	30
7. REFERENCE TABLE FOR ILLUMINATION STANDARD OF VARIOUS LOCATIONS.....	31

Introduction

Thank you for your purchase of the MS6612 multi-functional light meter designed and manufactured by our company.

This meter will, with proper use, provide years of reliable service; therefore, it is recommended that the user read carefully the user's manual before using the light meter and keep it in right place for reference.

For more information about the product,
please visit our website
<http://www.mastech.cn>.

Limited Warranty, Rights and Responsibilities

The product is guaranteed for one year from date of purchase against defects in material or workmanship. This warranty does not extend to damage caused by fire (fusing), disposable battery (exhausted), accidents, negligence, misuse, modification, pollution and abnormal operation. Dealers are not authorized to extend the warranty coverage on MASTECH's behalf. During the applicable limited warranty period, the user may contact the nearest MASTECH service center to obtain approval of information, and send the product to the center along with fault description.

Open-package inspection

Upon reception of the light meter, inspect it to ensure no damage happened during shipping. If the user finds obvious damage or malfunction in operation, please contact the supplier.

Attachments

Instruction manual × 1

One 9 V alkaline cell, GL6F22A 1604A

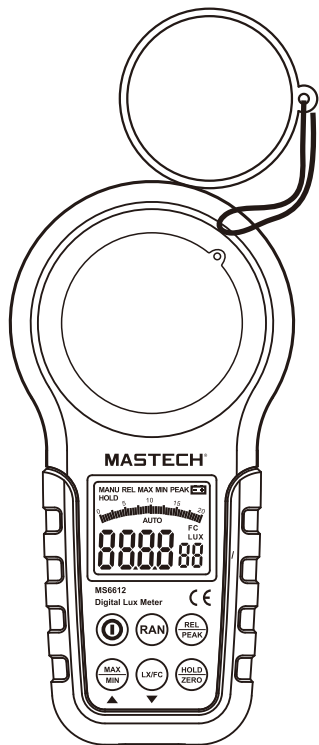

Safety information

Warning

Do not use the light meter in the environment full of dusts or having gas substances and flammable steam substances!

Safety mark description

This manual contains basic information for MS6612 safety operation and maintenance. Please read carefully following safety information before use.

Table 1: Safety information





	<p>Important information which the user must read before using the light meter</p>
	<p>Mark of conformity</p>

Table 2. Warning message

 Warning	It indicates that incorrect operation will lead to serious injury or even fatal accidents
 Notice	It indicates that incorrect operation or negligence will lead to meter damage or wrong measurement results, etc.
 Tips	Operation suggestions or prompts

 **Operation considerations**

User should observe the following notices to guarantee safe operation and obtain optimum performance.





1. Preliminary check

Before initial use, please check if the light meter operates normally and if it is damaged during storage and transportation. In case of any damage, please contact the supplier.

2. Placement

Operational temperature and humidity range	-10~50°C (14~122°F) <80%RH (non-condensed)
Storage temperature and humidity range	-10~+50°C (14~122°F) <70%RH (non-condensed)

To avoid faults, please **DO NOT** place the light meter in following environments:

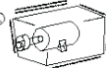
 Direct sunlight High temperature	 Corrosive or explosive gas
 Mist /splash High temperature /condensation	 Intensive electromagnetic environment
 Dust	 Mechanical vibration

3. Use

Notice

1. The operation temperature range for the light meter is -10-50°C (14-122°F).
2. In order to avoid damage, especially falling accidents, handling and use should be avoided during severe mechanical vibration.
3. The light meter can only be calibrated and repaired by professional personnel.
4. Before each use, the opto-sensor of light meter should be checked for damage and dust. Make sure the meter is in good, smooth and clean conditions. If one or more functions of the light meter are irregular or not ready for operation, avoid using the meter.
5. During the operation of the light meter, the meter measurement value should not be at OL for long time.
6. Keep the meter out of direct sunlight to guarantee its normal operation and long-term service life.
7. If the meter is subject to effect of intensive electromagnetic field, its functions will be affected.
8. Only use batteries specified in technical data.
9. Batteries should avoid damp. If the low battery symbol appears on the display, the user should replace batteries.

Tips

1. The sensibility of the optical detector will be lessened due to operation conditions or time. It is recommended to make periodic calibration to maintain the basic accuracy.
2. Please keep original package for future mailing (such as for light meter calibration).

1. Introduction

1.1 Product description

Whether you are a professional or amateur photographer, while shooting, you pay more attention to the surrounding illuminance rather than the setting, because this will help you taking the best shot. Although the illuminance can be estimated by the photographer, there is a difference in perception between human and camera about the requirement for supplementing illuminance. This difference will lead to a big contrast of the expected image effect against the actual one. In face of this, do you wish to possess a light meter? When you intend to buy a house, you require both good location and indoor brightness during the day. So, do you wish to possess a light meter to measure the illuminance in every corner of the house .

With the progress of human civilization, more and more people emphasize low carbon life. Architects tend to figure out how to bring more natural light into the house while putting up a residential building. However, in many cases, fluorescent lights will be used when the natural light is not enough. In response to the slogan of energy saving and emission reduction advocated by the state, we should use the fluorescent lamps based on the actual needs. So, a professional and convenient light meter can provide you with a reference regarding illuminance.

The MS6612 multi-functional light meter has a friendly human-machine interface and can be activated

by a simple press of keys. The buzzer activates upon key press to notify that it is effective. This light meter is able to measure the visible light produced by fluorescent lamp, metal-halide lamp, high voltage sodium lamp or electric incandescent lamp for a vivid and intuitive image display.

1.2 Outstanding features of the MS6612 multi-function light meter

- Automatic and manual range switching;
- Inquiry function for maximum and minimum values;
- Data hold function;
- Peak value measurement function;
- Relative value measurement function;
- Zero calibration function;
- 3 1/2 bit LCD display, with analog bar display;
- Fc/Lux unit conversion function;
- Outrange indication (When the measured value exceeds the current range, LCD will display the signal "OL" to indicate that the range is overreached);
- High precision. Measurement range (0.00~200000Lux);
- Low battery indicator;
- Touch tone and mute function;
- Auto power-off function (The machine will be powered off automatically keys are not operated for more than 10 minutes)
- Compact design, durable, and portable.

1.3 Name and function of components

1.3.1 Plan view

- ① Opto-sensor protection cover
- ② Opto-sensor
- ③ LCD display screen
- ④ Compound key for main power and touch tone:
Power on/off: Short press the key to activate the machine and long press for 1 second to shut it down.
Touch tone on/off: Under working mode, short press the key to turn on and off the touch tone.
- ⑤ Max and min values inquiry key
- ⑥ Lux/Fc unit conversion key
- ⑦ Compound key for data hold and zero calibration:
Data hold: Short press the key to enter/exit data hold mode.
Zero calibration: Long press for 1 second to perform zero calibration function.
- ⑧ Compound key for relative value and peak value measurement:
Relative value measurement: Short press the key to enter/exit relative value measurement mode.
Peak value measurement: Long press for 1 second to enter/exit peak value measurement mode.

- ⑨ Key for manual range switching: Short press the key for 20.00Lux 200.0Lux 2000Lux 20000Lux 200000Lux (or 20.00Fc 200.0Fc 2000Fc 20000Fc) circulation; Long press for 1 second to exit manual range switching mode.

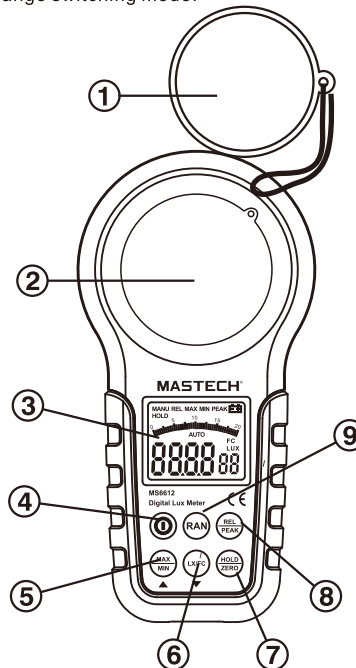

1.3.2 LCD display interface

- ① Prompt for manual range switching mode
- ② Prompt for data hold mode
- ③ The analog bar shows the current measurement value information.
- ④ The digit shows the current measurement value information.
- ⑤ Lux unit
- ⑥ FC unit
- ⑦ Prompt for auto measurement mode
- ⑧ Prompt for peak value measurement mode
- ⑨ Prompt for low battery
- ⑩ Prompt for relative value measurement mode
- ⑪ ⑫ Prompt for max and min values inquiry

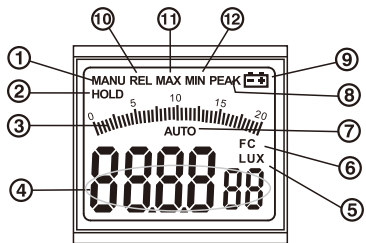

LCD display interface

2. Measurement methods

2.1 Notices prior to measurement

⚠ Warning

1. Do not use the light meter in environments full of dusts or having gas substances and flammable steam substances!
2. Do not use the light meter for measurement in the place with high temperature and high humidity.
3. Do not use the light meter in environments with intense infrared or ultraviolet rays!

⚠ Tips

1. The opto-sensor of this meter is designed by simulating the sensitive curve of light obtained through human eyes. The spectral coverage is between 320nm and 730nm. When it is used for measurement within the infrared range, there will be a large data deviation.
2. The opto-sensor is calibrated by common electric incandescent lamp required by CIE under the color temperature of 2854°K; the provided reading number may be different for the spectrum of other lamps.
3. The reference level of light source test is at the top of the spherical surface illuminated.
4. The optical detector should expose to light for 2 \ minutes before measurement.
5. Influence of tester's shadow and other factors on the optical detector should be avoided.

2.2 Action principles

2.2.1 Concepts of illuminance scales

One lux (lumen) indicates the illuminance got on a surface of one square meter, all points of which are one meter from a uniform source of one candela.

One foot-candle (Fc) indicates the illuminance got on a surface of one square foot, all points of which are one foot from a uniform source of one candela.

2.2.2 Unit conversion for illuminance scales

$$1 \text{ Fc} = 10.764 \text{ lux}$$

$$1 \text{ lux} = 0.09290 \text{ Fc}$$

2.2.3 Conversion formula for illuminance and light intensity

$$E = I / r^2$$

Wherein E --- illumination value (Unit: Lux);

I --- Light intensity of the light source (Unit: cd);

r --- Distance from the luminous surface of light source to the optical detector (Unit: m)

During the measurement, the minimum distance between the luminous surface of light source and the opto-sensor should be more than 15 times greater than maximum size of the luminous surface (or opto-sensor).

2.3 Typical practice cases

In the following practice cases, the user stands under a light source. Remove the protection cover of the MS6612 multi-functional light meter sensor and place it at right angle to the light source, as shown in figure 2-1.

Press and hold the MS6612 power key **Ⓚ** for a short time to power on the light meter. The LCD screen will illuminate (about 5 seconds) with the buzzer beeping twice, and "AUTO" will appear on the middle of LCD display. This indicates that the meter auto range switching mode is ON.

Press and hold the manual range switching key **Ⓜ** of the MS6612 for a short time, "MANU" will appear on the top left position of the LCD display, indicating that the manual range switching mode has been activated. In this mode, each time press and hold the key for a short time, the meter will switch to 20.00Lux→200.0Lux→2000Lux→20000Lux→200000Lux (or 20.00Fc→200.0 Fc→2000 Fc→20000 Fc) in sequence; pressing the key for one second will result in the inscription "MANU" disappearing from top left position of LCD display, replaced by "AUTO" appearing in the middle, to indicate that the meter has switched the manual range switching mode to the auto range switchover. Press and hold the REL/PEAK key **Ⓡ** of the MS6612 for a short time, "REL" will appear on the top left position of the LCD interface, indicating the activation of the relative value measurement mode. Press and hold the key **Ⓡ** for a short time again, the device will exit the relative value measurement mode and return to the original measurement mode, and "REL" on the top left position of the LCD interface will disappear; pressing the key for one second will lead to the peak measurement mode, "PEAK" and "MANU" will

appear on top right position of LCD display; press and hold the key for one second once again, "PEAK" and "MANU" will disappear from the top right position of the LCD interface, and "AUTO" will appear in the middle of LCD, and the mode will return to auto range switching measurement mode. Press and hold max/min value inquiry key **5** for a short time, "MAX" will appear on top position of LCD interface, switching the device to the max/min value inquiry mode; in this mode, each short press of the key causes the mode to change from MAX to MIN or from MIN to MAX; press and hold the "MAX/MIN" key **5** for one second, "MAX/MIN" on top position of the LCD interface will disappear, and the mode will exit. Press and hold the data hold/zero calibration key **7** of the MS6612 for a short time to enter the data hold mode, which will be indicated by the apparition of "HOLD" on the top left position of the LCD interface; press and hold the key for a short time once again, "HOLD" will disappear from the top left position of the LCD interface, and the device will exit the data hold mode. In any mode with sensor covered, press and hold data hold/zero calibration key **7** for one second, "ADJ" will appear on the LCD interface, and the device will enter the zero calibration mode: several seconds later "ADJ" will disappear from the LCD interface, and the device will exit the data hold mode and return to auto range switching measurement mode.



! Tips

1. The reference position of light source test is at top of sphere surface under light.
2. In various measurement modes, analog bar in the middle of the LCD screen will change with figures of Nixie tubes.
3. When reading, existing data can be locked by pressing and holding "HOLD/ZERO" key for a short time;
4. In zero calibration mode, the opto-sensor must be covered by opto-sensor visor before calibration.
5. After completing the test, the sensor protection cover should be put back to protect light filter and sensor.

3. Specific Application

3.1 Application of manual switchover of range measurement mode

- Press and hold the RAN key (range manual switchover key) for a short time, "MANU" will appear on the top left position of the LCD interface, and the meter will enter the manual switchover measurement mode (as shown in figure 3-1-1);
- When entering manual switchover of range function, press RAN key for a short time each time, it will switch to 20.00Lux→200.0Lux→2000Lux→20000Lux→200000Lux (or 20.00Fc→200.0 Fc→2000 Fc→20000 Fc) in sequence;
- Press and hold RAN key for one second, "MANU" on the top left position of the LCD interface will disappear, and "AUTO" will appear in middle of LCD interface, and manual range switchover function will exit and the device will return to auto range switchover measurement mode;

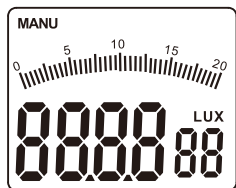
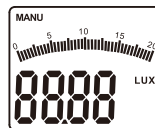
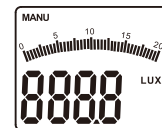

Figure 3-1-1



20.00Lux interface



200.0Lux interface

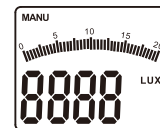

2000Lux interface

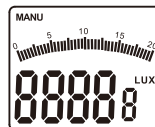

20000Lux interface

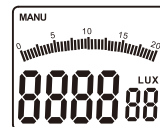

200000Lux interface



Tips

1. If no data hold/zero calibration mode, it will be effective to press RAN key for a short time.
2. In relative value measurement mode and max/min value inquiry mode, press and hold the key for one second, it will return to auto switchover of range.
3. In peak value measurement mode, data hold mode and zero calibration modes, it will be effective to press and hold RAN key for a long time.
4. In this mode, when measurement value exceeds present range, "OL" will appear on LCD interface to indicate over-range, and the user should switch over the measurement range at this time.

3.2 Application of relative/peak value measurement mode

- Press and hold REL/PEAK key for a short time (composite key for relative/peak value measurement), "REL" will appear on the top left position of the LCD interface (as shown in figure 3-1-2A), and the device will enter the relative value measurement mode;
- Press and hold REL/PEAK key for a short time again, "REL" on the top left position of the LCD interface will disappear, and the device will exit the relative value measurement mode and return to original measurement mode;
- Press and hold "REL/PEAK" key for one second, the device will enter the peak value measurement mode, "PEAK" LCD will appear on the top right position of the LCD interface, and at the same time, "MENU" will appear on the top left position of the LCD interface (as shown in figure 3-1-2B);
- Press and hold the key once again for one second, "PEAK" and "MENU" on top right position of LCD interface will disappear, and "AUTO" will appear on the middle of LCD interface, and the device will exit the peak value measurement mode and return to auto measurement mode (as shown in 3-1-2C).

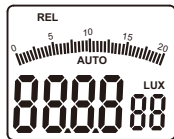

Figure 3-1-2A

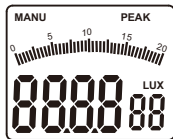

Figure 3-1-2B

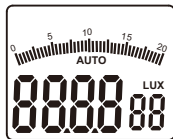

Figure 3-1-2C



Tips

1. In auto measurement mode, peak value measurement mode, max/min value inquiry mode and data hold mode, it will be effective to press and hold REL/PEAK key for a short time.
2. In non-zero calibration mode, press and hold "REL/PEAK" for one second, the device will enter the peak value measurement mode.

3.3 Application of maximum/minimum value inquiry mode

- Press and hold "MAX/MIN" key for a short time, "MAX" will appear on top LCD interface (as shown in figure 3-1-3);
- In max/min value inquiry mode, press "MAX/MIN" key once, you will switch MAX to MIN or MIN to MAX;
- Press and hold "MAX/MIN" for one second, "MAX/MIN" on top LCD interface will disappear, and the max/min value inquiry mode will exit.

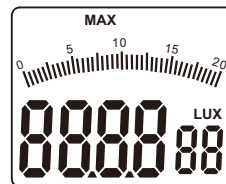

Figure 3-1-3

Tips

In non-zero calibration mode, press and hold "MAX/MIN" key for a short time to use the max/min value inquiry functions;

3.4 Application of data hold and zero calibration mode

- Press and hold "HOLD/ZERO" key for a short time, "HOLD" will appear on the top left position of the LCD interface (as shown in 3-1-4A), then the device will enter the data hold mode;
- Press and hold the key again, "HOLD" on the top left position of the LCD interface will disappear, and the meter will exit the data hold mode;
- Cover the opto-sensor with the visor, and press and hold "HOLD/ZERO" key for one second, "ADJ" will appear on LCD interface (as shown in figure 3-1-4B), then the device will enter the zero calibration mode. Several seconds later, "ADJ" on LCD interface will disappear, and zero calibration mode will automatically exit and return to auto measurement mode.

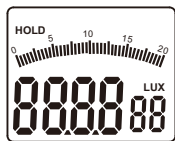

Figure 3-1-4A



Figure 3-1-4B

Notice

Before zero calibration, the opto-sensor must be covered with the opto-sensor visor.

Tips

1. In non-zero calibration mode, press and hold "HOLD/ZERO" key for a short time to enter the data hold mode.
2. Zero-calibration can be made in any mode.

4. Other Functions

4.1 Auto power-off

If there is no action on keys of the MS6612 for a long time, the meter will automatically power off about 10 minutes later.

4.2 Mute

Under working mode, short press the MS6612 power key

④ to turn on and off the touch tone.

5. Technical Data

- Temperature range:
Operation: -10~50°C, max 80 % HR (Non-Condensed)
Storage: -10~50 °C, max 80 % HR (Non-Condensed)
(removing batteries)
- Sampling rate: ≥ 2 times/s
- Display: 3½ digits, max reading of 1999, with analog bar display;
- Sensor: silicon photoelectric diode
- Measured spectral range: 320~730nm
- Measurement ranges: 20, 200, 2000, 20000, 200000 Lux
20, 200, 2000, 20000 FC
- Operating environment: indoor use
- Height: 2000m highest
- Battery life: Approx. 200 hours
- Sensor: silicon photoelectric diode
- Power supply: 1×9 V, IEC 6LR61
- Dimensions (H×W×D): 170x89x43mm
- Weight: Approx. 360 g without batteries
Approx. 420 g with batteries
- Accuracy: $\pm 3\%$ (calibrated with incandescent lamps in 2854K)
 $\pm 6\%$ other visible light source

Cosine angle deviation characteristics	
Cosine angle	Deviations
30°	±2%
60°	±6%

Tips: cosine angle is corrected in accordance with JIS C 1609:1993 and CNS 5119 Grade A General Specification.

Luminous sensitivity characteristics:

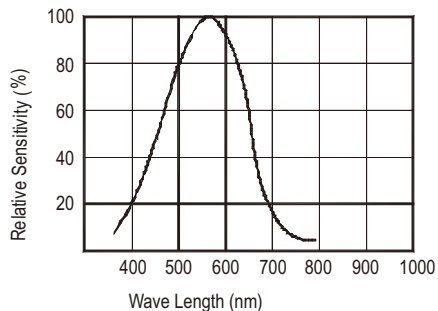

6. Maintenance and Service

6.1 Service

⚠ Notice

When the meter seemingly fails during operation, following steps should be followed to check the fault problem:

1. Check up batteries. If "E3" appears on the LCD display, batteries should be replaced.
2. Refer to the operation instructions to check if operation steps are wrong.
3. Before sending the meter to manufacturer for repair, the user should remove out the batteries and describe faults in details, and pack the meter to avoid damages in transportation. Our company will assume no responsibility for damages in transformation.
4. Repair on the meter should be performed by service centers or other qualified servicemen.

6.2 Cleaning

First wipe the meter with a damp soft cloth with clean water or neutral detergent and then with a dry cloth.

⚠ Notice

1. Please make sure the light meter is turned off before cleaning.
2. Do not use benzene, alcohol, acetone, ethyl ether, ketones, thinners and gasoline, etc. in cleaning, because they will transform or fade the light meter.
3. The light meter can only be used again when it is completely dry after cleaning.

6.3 Battery replacement

If the battery symbol appears on the LCD accompanied by buzzer alarm, batteries must be replaced.

Batteries should be replaced as follow:

- Turn off the meter;
- Remove the screw on the back of the meter and open the battery compartment;
- Remove exhausted batteries;
- Replace new batteries observing polarity;
- Replace the battery compartment cover and secure the compartment screw.

Warning

- 1: Do pay attention to the right polarity of battery when putting in or replacing batteries. In case of polarity reversal, the light meter will be damaged, and can even cause explosion or fire.
- 2: Neither connects one polarity of the battery to the other one with wire, nor throws batteries into fire, or it will cause explosion.
- 3: Do not attempt to discompose the battery! The battery's intensively alkaline electrolyte is corrosive and endangers the user. In case of contact of the electrolyte with skin or clothes, immediately rinse touched parts with clean water; in case of contact of the electrolyte with eyes, immediately rinse eyes with clean water and seek medical advice.

Notice

1. The light meter should be turned off before replacing batteries.
2. Use batteries specified in technical data only.
3. If the meter is not to be used for a long time, take out the batteries. In case the meter is polluted due to battery leak, the meter should be sent by post to the manufacturer for cleaning and checking.
4. For disposal of used batteries, follow existing specifications on battery recycling, reuse and treatment.

6.4 Calibration Interval

In order to ensure the accuracy of the meter, periodic calibration should be performed by our debugging personnel.

It is recommended to make calibration every year. If the meter is in frequent use or used in poor environments, the calibration interval should be accordingly shorten. If the meter is less used, the calibration interval may prolong to three years.

7. Reference Table for Illumination Standard of Various Locations

Fc illumination value can be got from Lux illumination value divided by 10.6.

Schools:

Illuminance (Lux)	Locations
1500~300	Drafting classroom, sewing classroom, computer classroom
750~200	Classroom, laboratory, practice workshop, research room, reading room, stack room, office, staff lounge, conference room, health center, restaurant, kitchen, pantry, radio room, printing room, switchboard room, guard room, indoor stadium
300~150	Large classroom, auditorium, storage cabinet room, lounge, staircase
150~75	Corridor, elevator corridor, toilet, duty room, workers room, bridge, school outdoor playground
75~30	Warehouse, garage, fire escape

Office:

Illuminance (Lux)	Locations
2000~1500	Design office, clerk's office
1500~750	Hall information channel (daytime), parlor, drawing office, punching, typing
750~300	Calculator room, conference room, printing room, switchboard room, control room, reception room, recreation room, restaurant
300~150	Stack room, entertainment room, dining room, lounge, guard room, elevator (passway), washroom, toilet
150~75	Tea room, changing room, warehouse, nightwatchmen office (entrance)
75~30	Fire escape

Factories:

Illuminance (Lux)	Locations
3000~1500	Ultra-precision operation, design, drafting, precision inspection
1500~750	Design office, analysis, assemble line, coating
750~300	Packaging, measurement, surface treatment, warehouse office
300~150	Dyeing, casting, electrical room
150~75	Entrance and exit, corridor, information channel, staircase, dressing room, toilet, operation warehouse
75~30	Fire escape, warehouse, outdoor power equipment (loading and unloading, inventory move operation)

Hospital:

Iluminance (Lux)	Locations
10000~5000	Visual function test chamber (ophthalmology lightroom)
1500~750	Operating room
750~300	Consulting room, treatment room, pharmacy room, prescription room, drug store, dissection room, pathological bacteria room, emergency rooms, maternity ward, dean's office, offices, nursing room, conference room
300~150	Ward, medicine room, bed reading, medicine changing, plaster bandage for fractures, infant room, record room, waiting room, consulting room, outpatient corridor
150~75	Locker room, physical therapy room, X-ray room, ward corridor, medicine room, sterilization room, ward room, stairs, endoscopy room
75~30	Animal room, dark room (photo), fire escape

Hotel, restaurant, recreation ground:

Iluminance (Lux)	Locations
1500~750	Counter
750~300	Halfway, banquet hall, business room, parking lot, kitchen
300~150	Restaurant, toilet, a large Japanese-style room
150~75	Recreation room, corridor, stairways, guest room, bathroom, accent lighting for gardens, changing room
75~30	Fire escape

Hair salon:

Iluminance (Lux)	Locations
1500~750	Haircut, perm, hair dyeing, cosmetics
750~300	Shave, hairdressing, lobby registration counter, makeup
300~150	Toilet in salon
150~75	Corridor, stairways

Shop, department store:

Iluminance (Lux)	Locations
3000~750	Indoor display, decorative window display, demonstration area, checkout counter, packaging table
750~300	Elevator lobby, escalators
300~150	Discussion room, dressing room, toilet, stairs, walkways
150~75	Lounge, general lighting in store

House:

Iluminance (Lux)	Locations
2000~750	Handcraft, tailoring
1000~500	Writing, work
750~300	Reading, makeup, kitchen table, processing area, telephone
300~150	Wash sink, entertainment room, living room, family reunion, entrance (inside) mirror
150~70	Wardrobe, bedroom, bathroom, stairs, corridor
75~30	Doorplate, mailbox, doorbell key, terrace



00-05-2706