

UNI-T®



UT191E/T

Operating Manual



Professional Multimeter

P/N:110401107044X



Table of Content

I. Introduction	1
II. Open Box Inspection	2
III. Safety Instructions	3
IV. Symbols	5
V. General specifications	6
VI. Structure	7
VII. LCD display	8
VIII. Functional dial and buttons	10
IX. Operation instructions	13
X. Technical specifications	28
XI. Maintenance	34

I. Introduction

UT191E/T is a reliable and safe multifunctional industrial digital multimeter.

The special features of this series are:

- Auto scale memory function: Recalls the settings used last time, even when powered off.
- Multifunctional measurement: AC/DC voltage and current, resistance, diode, continuity, capacitance, frequency, and duty ratio.
- Accurate °C/°F temperature measurement with resolution up to 0.1°C (UT191T Only).
- IP65 rated, 2m drop test, suitable for oil, chemical, aerospace, or strong electric field environment.
- Large LCD screen, 6000-count dual slope AD converter (3 times/s).
- 6kV pulse voltage protection
- True RMS AC voltage/current for non-linear signal measurement
- Peak value AC voltage/current measurement
- Support measurement of up to AC/DC 600V/20A.
- Low pass filter (LPF) function
- LoZ voltage measurement
- MAX/MIN value display
- REL mode
- Auto/manual measurement
- Auto backlight
- GS/CE/cTUVus certified
- 31 analog bars for quick observation of the test results.

II. Open Box Inspection

Open the package box and take out the device. Please check whether the following items are deficient or damaged, and contact your supplier immediately if they are.

User manual -----	1 pc
Test leads-----	1 pair
K-type thermocouple (UT191T)-----	1 pc
9V DC battery (6F22,1604A or 6LR61 type) -----	1 pc

III. Safety Instructions

Safety Standards

1) CE (EMC, LVD, RoHS), GS certification standards:

- EN 61010-1: 2010;
- EN 61010-2-033:2012; Safety requirements for hand-held electrical equipment for measurement, control, and laboratory use.
- EN 61010-031:2015; Safety requirements for probes connected to the device
- EN 61326-1:2013; EMC requirements for electrical equipment
- EN 61326-2-2:2013
- UL 61010-1, 3rd ed., 2012
CAN/CSA-C22.2 NO. 61010-1-12
- UL 61010-031, 2nd ed., 2017
CAN/CSA-C22.2 No. 61010-031:17
- UL 61010-2-033, 1st ed., 2014
CAN/CSA-C22.2 NO. 61010-2-033:14
- AfPS GS 2014:01
- EN 60529:1991+A1+A2

2) CAT III 600V: Suitable for testing and measuring circuits connected to the power distribution section of a building's low voltage power supply unit.

3) Pollution grade II

4) Double insulation safety standard

Please read this manual thoroughly before use. It is recommended to keep the manual at an easily accessible place for future reference.

Safety Instructions

- 1) This instrument can only be used and maintained by trained professionals.
- 2) To avoid electric shock, take safety precautions when operating voltage is higher than 60V DC or 30Vrms AC.
- 3) This instrument can only be used for measuring current <20A current, and its nominal voltage is 600V (CAT III).

- 4) When measuring dangerous electrical devices, it must be conducted under the direction of a qualified electrician.
- 5) Only the limited control area can be touched, and the display components cannot be covered.
- 6) The fuse replacement must be performed by a qualified professional. Before opening the rear cover of the instrument, turn off the instrument first and disconnect all circuits.
- 7) Do not disassemble the instrument by yourself.
- 8) Use only accessories that come with this product or with the same specifications.
- 9) Any modification or change to the instrument will void all warranties and warty claims from the manufacturer.
- 10) Do not use this instrument in an explosive environment.
- 11) Do not use the instrument when the battery cover is open.
- 12) Before use, please check whether the battery should be replaced.
- 13) Store the instrument in a dry place.
- 14) If the battery leaks, do not use this instrument until our customer service staff checks it.
- 15) The battery acid (electrolyte) is high-alkaline and can conduct electricity. There might be a risk of acid burns! If the battery acid comes in contact with your skin or clothes, immediately rinse thoroughly with plenty of clean water. If the battery acid is splashed into an eye, immediately flood with clean water and seek medical advice.
- 16) Please stop using the instrument if the following is not guaranteed to be safe for the operator and the surrounding personnel:
For example:
 - The shell is damaged.
 - The test leads appear damaged.
 - The battery is leaking.
 - Stored in an unsuitable place for a long time.
- 18) Replace the test leads if the insulating layer appears damaged.
Warning: Replace the test leads that meet the safety standards of EN 61010-031, CAT III 600V, and can measure current of 20A or above.

Application

This device complies with CAT III 600V measurement category.

CAT III is used in outdoor three-phase power supply devices, such as power distribution of power plant, protection system of electric meters and connecting devices of outdoor buildings.









The rated voltage of probe kit for mains measurement should comply with IEC 61010-031 category III, and that should be the maximum voltage of the circuit being measured.

This device should be used in applications listed in this manual. Any misuse of device may result in accident or damage to the device, and may void any rights to dealer claims and warranty.

The manufacturer will not liable for property damage and personal injury caused by following reasons:

1. Operations not following the instruction manual
2. Modifying the device without prior approval from manufacturer
3. Using 3rd party accessories without prior approval from the manufacturer
4. Using this instrument under the influence of alcohol, drugs, or other judgment impairment substances.
5. Using the device in potential explosive or high moisture/rainfall environment.

IV. Symbols

	AC/DC		Grounding
	Warning		Complies with European Union Directives
	Double insulation		Tested and approved by TÜV Product Services
	High voltage		cTUVus certification

V. General specifications

- 1) Max voltage between input terminal and earth grounding: 600V
- 2) Fuse Type:
 - 20A Jack: FF 11A H 1000V Fuse (Φ10x38) mm
 - mA/μA Jack: FF 600mA H 600V Fuse (Φ6x32) mm
- 3) Display count: 6000

Others:

- 1) Range: Auto/manual
- 2) Polarity: Auto
- 3) Display updates 3 times for every second. Over-range Indicator: "OL"
- 4) Operating temperature: 0°C~40°C (32°F~104°F)
Storage temperature: -10°C~50°C (14°F~122°F)
Relative humidity: ≤75% at 0°C~30°C; ≤50% at 30°C~40°C
- 5) Operating altitude: 0~2000m
- 6) Battery type: 9V DC battery (6F22,1604A or 6LR61 type)
- 7) Low power indicator: 
- 8) Dimension: 180mm×87mm×59mm
- 9) Weight: 428g (with battery)
- 10) Electromagnetic compatibility:
 - RF ≤ 1V/m, overall accuracy = specified accuracy + 5% of range.
 - RF > 1V/m, no specified calculation.

VI. Structure

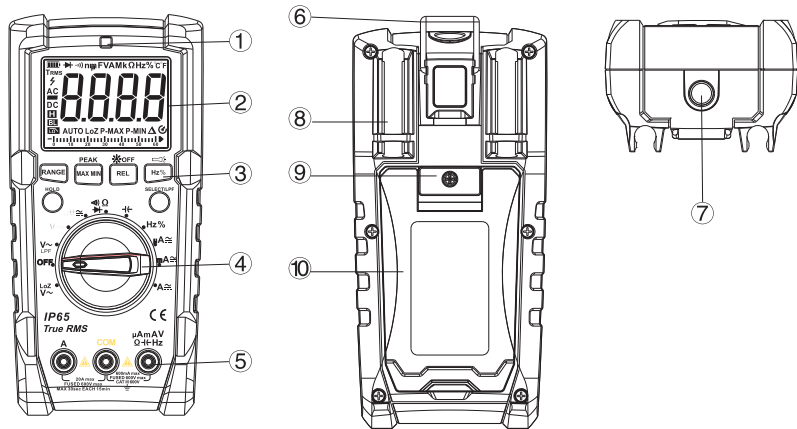

1	Backlight sensing window	6	Hook
2	LCD screen	7	Flashlight
3	Functional buttons	8	Test leads holding stand
4	Multifunctional dial	9	Battery cover screw
5	Input jacks	10	Case holder

VII. LCD display

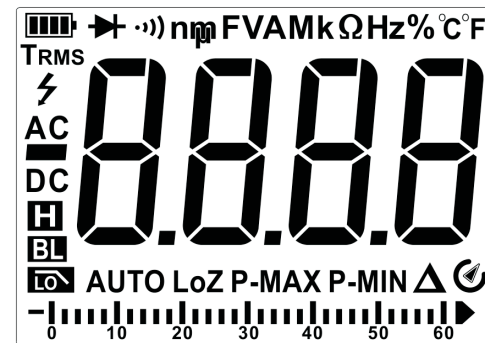

Symbol	Note
TRMS	True RMS value measurement
H	Data hold
⚡	High voltage
P-MAX/P-MIN	Peak value
-	Negative number

AC/DC	AC or DC measurement
LoZ	AC low impedance
	Power indicator
AUTO	Auto range selection
	Diode measurement/Continuity measurement
	LPF
Ω , $k\Omega$, $M\Omega$	Unit of resistance
Hz, kHz, MHz	Unit of frequency
%	Unit of duty cycle
mV, V	Unit of voltage
μA , mA, A	Unit of current
nF, μF , mF	Unit of capacitance
$^{\circ}C/^{\circ}F$	Celsius degree/Fahrenheit degree
BL	Backlight
	Auto power off
	31 segments of bar graph
	Reading value
	Relative value measurement

VIII. Functional dial and buttons

Position	Note
V \sim , V \approx , mV \approx	Voltage measurement (AC/DC)
Ω	Resistance measurement
	Diode measurement
	Continuity measurement
	Capacitance measurement
Hz	Frequency measurement
%	Duty cycle measurement
$^{\circ}C/^{\circ}F$	Temperature measurement
$\mu A \approx$ mA \approx A \approx	AC/DC current measurement
LPF V \sim	Low pass filter AC voltage measurement
LoZ V \sim	Low impedance AC voltage measurement
OFF	Shutdown

Buttons :

Note: Any time when the button is pressed, it beeps once, if the button is pressed and the function is invalid, it beeps twice. Short press means pressing the button for less than 2 seconds, and long press is more than 2 seconds.



RANGE :

Auto/manual range switching: Short press the RANGE button to enter the manual range. For every short press, it will jump to the next higher range, and will jump back to the lowest range after reaching the highest range. Long press RANGE or switch the dial to exit the manual range. (only for $V\sim$, V_{rms} , Ω , Hz, μA_{rms} , mA_{rms} , A_{rms})

MAX/MIN :

1. Short press the MAX MIN button to view the Max value or Min value, long press the button or switch the dial to exit this mode. (only for LOZ $V\sim$, LPF $V\sim$, $V\sim$, V_{rms} , mV_{rms} , Ω , μA_{rms} , mA_{rms} , A_{rms} , $^{\circ}C/^{\circ}F$ (UT191T))
2. Long press this button to obtain/exit peak value. Short press this button to cycle through P-MAX, P-MIN value. (only for $V\sim$, $mV\sim$, $\mu A\sim$, $mA\sim$, $A\sim$)

REL :

1. Short press the REL button to enter the relative value measuring mode: The device will save the value displayed as a reference value, and during the measurement process, it will display the difference value between the measured value and reference value. Short press the button again to exit this mode.
To exit his mode, press the button for 2 seconds.
(only for LOZ $V\sim$, LPF $V\sim$, $V\sim$, V_{rms} , mV_{rms} , Ω , $^{\circ}C/^{\circ}F$ (UT191T), μA_{rms} , mA_{rms} , A_{rms} measurement);
when measuring capacitance, REL button is only used for eliminating intrinsic value.
2. Long press REL to turn on/off the auto backlight function:
On:  symbol appears on the screen
Off:  symbol disappears on the screen

Hz/% :

1. At Hz% position, press the button to cycle through frequency and duty cycle measurement.
2. At other position, press this button to cycle through frequency, duty cycle and the present function. (only for LOZ $V\sim$, LPF $V\sim$, $V\sim$, $mV\sim$, $\mu A\sim$, $mA\sim$, $A\sim$)
3. Long press this button to turn on/off the flashlight



SELECT :

1. Select functions. (only for multiple modes)
2. Disable auto off function: Long press this button and turn on the device to disable auto off function,  disappears. Restart the device to recover auto off function (do not press SELECT).

HOLD :

Press the button once to hold the reading the LCD screen will show the '' symbol. Press again to unlock the reading and enter general measurement modes.

IX. Operation instructions

Please check the internal battery first, replace the battery in time if the “” symbol appears on the screen. Also pay special attention to the warning sign “” besides the test lead jacks, which indicates that the tested voltage or current must not exceed the values listed on the device.

1. AC/DC voltage measurement

- 1) Switch the dial and press SELECT to select function.(V~, V-, mV~, mV- or LPF V~)
- 2) Insert the red test lead to $\mu\text{A mV}$ (UT191E) or $\mu\text{A mV } \text{C}^{\text{F}}$ jack (UT191T), black to COM jack.
- 3) Connect the test lead probes to the correct test points in the circuit to measure the voltage.

Warnings:

- Do not input voltage over 600Vrms, It is possible to measure higher voltages, however, it may cause damage to the instrument.
- Be cautious to avoid electric shock when measuring high voltage.

Notes:

- Before using the device, it is suggested to measure a known voltage for verification.
- The input impedance of the instrument is about 10 M Ω , this load may cause error when measuring the high impedance circuit. In most cases, if the impedance of the circuit is under 10 k Ω , this error can be ignored ($\leq 0.1\%$).
- The input impedance of the DC mV scale is infinite ($\geq 1\text{G}\Omega$), and it does not attenuate when measuring weak signals, so the measurement accuracy is high. When the test leads are open, there may be a value on the screen, this is normal and will not affect the measurement result.
- Under ACV mode, press SELECT button to enter LPF function to filter high frequency interference signal. (applicable for variable frequency voltage)
- Readings of AC measurement are true RMS.
- At AC voltage position, long press PEAK to enable peak value function. Response time: 1ms. Short press to cycle through P-MAX, P-MIN value.
- At AC voltage position, press Hz% button to enter frequency measurement. Testing range is 40Hz~400Hz. During frequency measurement, input amplitude $\geq \text{range} \times 10\%$.

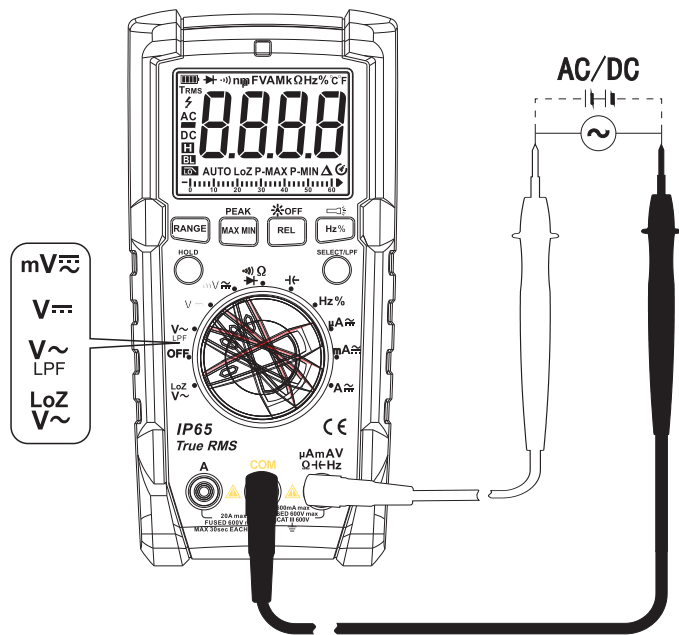

2. LoZ (low impedance) ACV measurement

- 1) Switch the dial to V_{\sim} .
- 2) Insert the red test lead to μAmAV (UT191E) or $\mu\text{AmAV}^{\text{CF}}$ (UT191T) jack (UT191T), black to COM jack.
- 3) Connect the test lead probes to the correct test points in the circuit to measure the voltage.

⚠ Notes:

- Do not input over 600Vrms or it may damage the device.
- Pay attention when measuring high voltage.
- Before using the device, it is suggested to measure a known voltage for verification.
- After using LoZ function, wait for 3 minutes for next operation.
- In order to eliminate fake voltage, LoZ provides low impedance ($300\text{k}\Omega$) for accurate measurement
- AC measurement displays True RMS value.

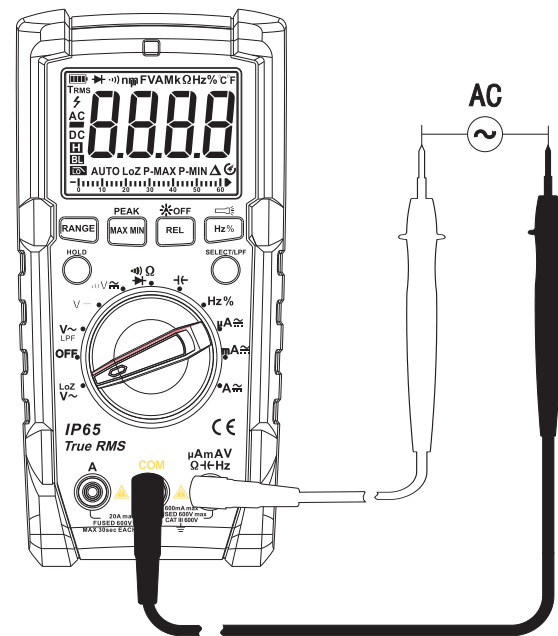

3. Resistance measurement

- 1) Switch the dial to Ω (UT191E) or Ω (UT191T)
- 2) Press SELECT until the resistance mode is activated.
- 3) Insert the red test lead to μAmAV (UT191E) or $\mu\text{AmAV}^{\text{CF}}$ (UT191T) jack, black to COM jack.
- 4) Connect the test lead probes to the correct test points in the circuit to measure the resistance.

⚠ Notes:

- If the resistor is open or over the range, the "OL" symbol will be displayed on the screen.
- Before measuring resistance, switch off the power supply of the circuit, and fully discharge all capacitors.
- When measuring low resistance, the test leads will produce 0.1 Ω ~0.2 Ω measurement error.
To obtain accurate measurement, short the test leads and use REL function.
- If the resistance when shorted is more than 0.5 Ω , please check if test leads are loosened or damaged.
- When measuring high resistance above 60M Ω , it is normal to take a few seconds to steady the readings.

4. Continuity measurement

- 1) Switch the dial to Ω (UT191E) or Ω (UT191T)
- 2) Press SELECT until the continuity mode is activated.
- 3) Insert the red test lead to μAmAV (UT191E) or $\mu\text{AmAV}^{\text{CF}}$ (UT191T) jack, black to COM jack.
- 4) Connect the test lead probes to the correct test points in the circuit.
- 5) When measuring resistance >100 Ω , circuit is broken, buzzer does not go off. When measuring resistance $\leq 30\Omega$, circuit is in good conduction status, buzzer will go off continuously. If OL appears on the screen, circuit is in open status.

⚠ Warnings:

- Before checking the continuity, switch off the power supply to the circuit, and fully discharge all capacitors
- Do not input over 60V DC or 30V AC or it will pose shock hazard.

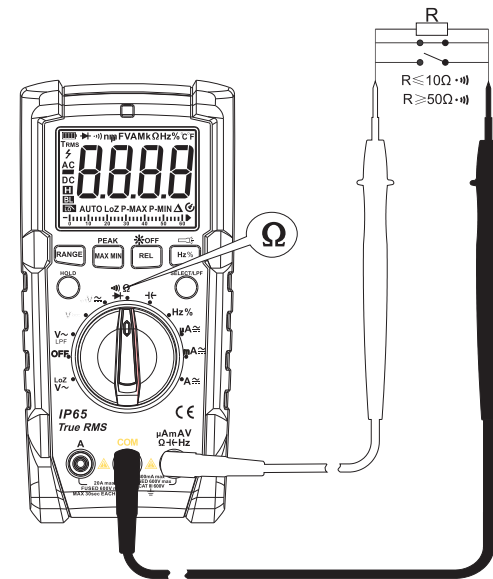

5. Diode measurement

- 1) Switch the dial to $\rightarrow \Omega$ (UT191E) or $\rightarrow \Omega$ (UT191T)
- 2) Press SELECT to until the diode mode is activated.
- 3) Insert the red test lead to $\mu\text{A m A V}$ (UT191E) or $\mu\text{A m A V}$ (UT191T) jack, black to COM jack.
- 4) Red test lead probe to positive pole, black to negative pole.
- 5) "OL" symbol appears when the diode is open or polarity is reversed. For silicon PN junction, normal value: 500~800mV (0.5~0.8V).

⚠ Warnings:

- Do not input over 60V DC or 30V AC or it will pose shock hazard.

⚠ Notes:

- Before measuring the diode online, switch off the power supply to the circuit, and fully discharge all capacitors
- Voltage for testing diode is about 3V.

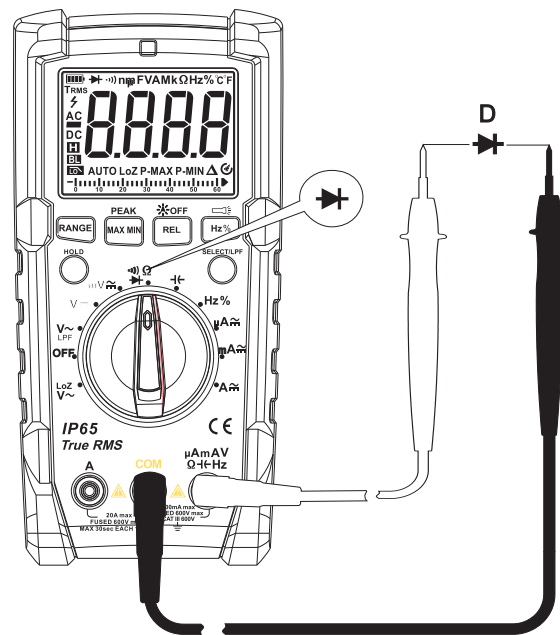

6. Capacitance measurement

- 1) Switch the dial to $\text{M}\Omega$ (UT191E) or $\text{G}\Omega$ (UT191T)
- 2) For UT191T, press SELECT until the capacitance mode is activated.
- 3) Insert the red test lead to $\mu\text{A mAV}$ (UT191E) or $\mu\text{A mAV}^{\text{C}}\text{F}$ (UT191T) jack, black to COM jack.
- 4) Connect test leads to the pins of capacitor

⚠ Notes:

- Before measuring, fully discharge all capacitors especially for the capacitors with high voltage to avoid damage to the instrument and personal injury.
- If the tested capacitor is shorted or its capacitance is over the specified range, "OL" symbol will be displayed on the screen.
- When measuring large capacitors, it may take a few seconds to obtain steady readings.
- When there is no input, the device displays a fixed value (intrinsic capacitance). For small capacitance measurement, to ensure measurement accuracy, this value must be subtracted from the measured value, or you can use the REL function for doing the subtraction automatically.

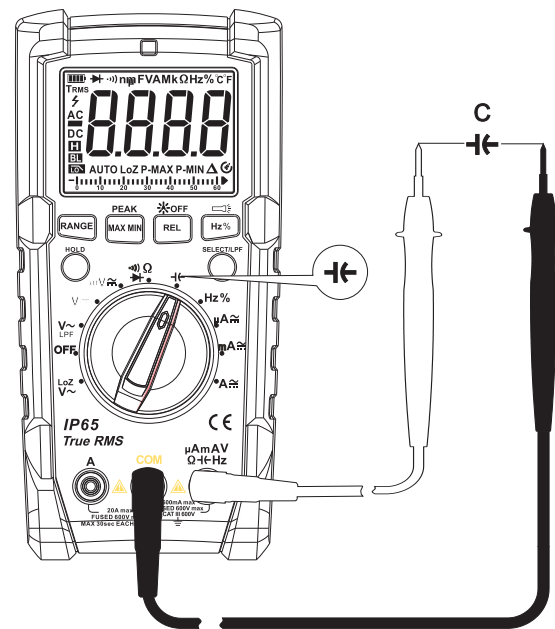

7. Frequency/ Duty cycle measurement (Only for AC positions)

- 1) Switch the dial to Hz% position
- 2) Insert the red test lead to μAmAV $\Omega\text{-Hz}$ (UT191E) or $\mu\text{AmAV}^{\circ\text{C}/\text{F}}$ (UT191T) jack, black to COM jack.
- 3) Connect the test leads with tested points
- 4) Short press Hz% or SELECT to switch between frequency or duty cycle measurement.

⚠ Warnings:

- Do not input over 60V DC or 30V AC or it will pose shock hazard.

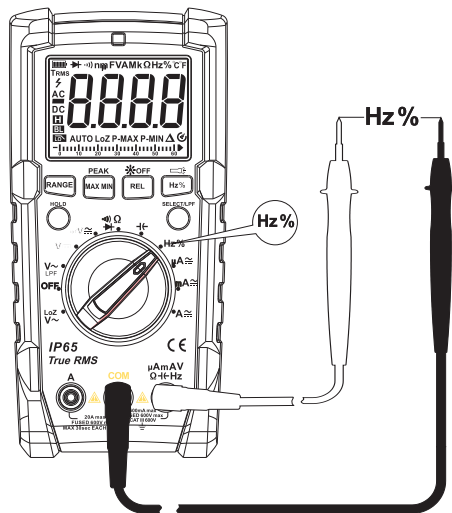

8. Temperature measurement (only for UT191T)

- 1) Switch the dial to $^{\circ}\text{C}/\text{F}$
- 2) Insert K-type thermocouple to $\mu\text{AmAV}^{\circ\text{C}/\text{F}}$ jack (with "+" mark) and COM jack (with "-" mark).
- 3) Reading is displayed.
- 4) Press SELECT to switch between $^{\circ}\text{C}$ and $^{\circ}\text{F}$.

⚠ Note:

- Only K-type thermocouple is applicable.
- The measured temperature should be less than $400^{\circ}\text{C}/752^{\circ}\text{F}$ ($^{\circ}\text{F} = ^{\circ}\text{C} * 1.8 + 32$)
- When device is turned on without probe inserted, 'OL' symbol appears.

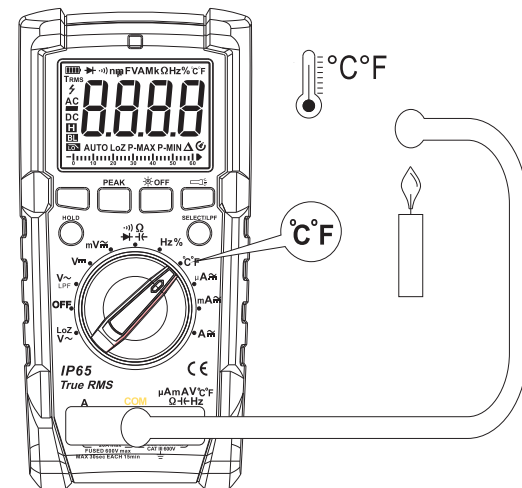

9. AC/DC current measurement

- 1) Switch the dial to μA , mA or A .
- 2) Press SELECT to switch between AC and DC current.
- 3) According to the current being measured. Insert the red test lead to A jack or μmA jack, black to COM jack.
- 4) Connect test leads with the circuit in series.
- 5) Reading is displayed.

⚠ Notes:

- To prevent possible electric shock, fire or personal injury, switch off the power supply of the circuit, and then connect the instrument with the circuit in series before measuring the current.
- If the range of the measured current is unknown, select the maximum range and then accordingly reduce.
- There are fuses inside 20A jack and mA/ μA jack. Do not connect the test leads with any circuits in parallel.
- Under AC mode, readings are true RMS.
- If the tested current is 10A~20A, each measurement time should be about 10 seconds (max for 30s) and the next test should be after 15 minutes.
- At AC current position, long press PEAK to enable peak value acquisition, response time 1ms, short press to switch between P-MAX, P-MIN value.
- When measuring AC current, press Hz/% button to display AC frequency or duty ratio. Frequency range: 40Hz~400Hz, when measuring the frequency input amplitude \geq min. range $\times 50\%$

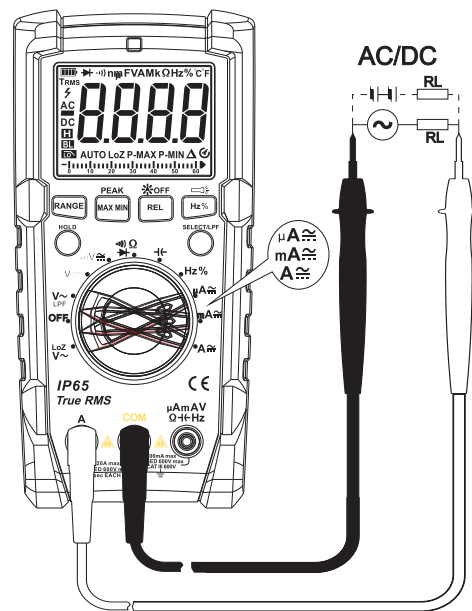

10. Others:

Auto power off: The device automatically shuts down if there is no operation for 15 minutes. You can wake up the device by pressing any key or switching the dial. To disable auto shutdown, switch the dial to OFF position, long press SELECT button and turn on the device. Recover the auto-off function by restarting the device.

- Auto backlight: Under dark circumstance (Illuminance $\leq 30\sim 50$ Lux), LCD backlight will be activated automatically (last 30s). Under bright circumstance (Illuminance > 50 Lux), backlight will automatically shut down.
- Buzzer: When AC/DC voltage > 600 V, current > 10 A, buzzer will go off intermittently.
- Low voltage alarm: when voltage < 6.1 V,  appears.

X. Technical specifications**⚠ Notes:**

To ensure accuracy, operating temperature should be within $18^{\circ}\text{C}\sim 28^{\circ}\text{C}$.
Temperature Coefficient = $0.1 \times (\text{specified accuracy}) / ^{\circ}\text{C}$ ($< 18^{\circ}\text{C}$ or $> 28^{\circ}\text{C}$)

1. DC voltage

Range	Resolution	Accuracy
600.0mV	0.1mV	$\pm (0.7\% + 3)$
6.000V	0.001V	$\pm (0.5\% + 3)$
60.00V	0.01V	$\pm (0.7\% + 3)$
600.0V	0.1V	

⚠ Input impedance: mV mode: $\geq 1000\text{M}\Omega$, other mode: about $10\text{M}\Omega$.
(For short circuit, mV range allows ≤ 5 digits, other ranges: return to 0)
Max input voltage: ± 600 V

2. AC voltage

Range	Resolution	Accuracy
600.0mV	0.1mV	$\pm (1.0\%+4)$
6.000V	0.001V	$\pm (0.7\%+3)$
60.00V	0.01V	$\pm (1.0\%+3)$
600.0V	0.1V	$\pm (1.0\%+3)$
AC LoZ 600.0V	0.1V	$\pm (2.0\%+5)$
ACV LPF 600.0V	0.1V	$\pm (2\%+5)$

-  ● Input impedance: about 10M Ω
- Displays true RMS. Frequency response: 40 ~ 400Hz. LPF frequency response: 40 ~ 200Hz.
After using LoZ function, please cool down the device for 1 minutes.
 - Accuracy guarantee range: 1~100% of the range, shorted circuit allows least significant digit ≤ 10
AC crest factor at Max range=3.0
- Non-sine wave:
Crest factor of 1.0 ~ 2.0, accuracy must be increased by 3.0%
Crest factor of 2.0 ~ 2.5, accuracy must be increased by 5.0%
Crest factor of 2.5 ~ 3.0, accuracy must be increased by 7.0%
Max input voltage: 600Vrms.



3. Resistance measurement

Range	Resolution	Accuracy
600.0 Ω	0.1 Ω	$\pm (1.0\%+2)$
6.000k Ω	1 Ω	$\pm (0.8\%+2)$
60.00k Ω	10 Ω	
600.0k Ω	100 Ω	
6.000M Ω	1k Ω	$\pm (1.2\%+3)$
60.00M Ω	10k Ω	$\pm (2.5\%+5)$

* Measurement result = reading of resistor – reading of shorted test leads

 Overload protection: 600V

4. Continuity, Diode

Range	Resolution	Accuracy
	0.1 Ω	Set Value: Open circuit: resistance $\geq 100\Omega$, no beep. Well-connected circuit: resistance $\leq 30\Omega$, continuous beeps.
	1mV	Open circuit voltage: 3.0V Silicon PN junction voltage: 0.5 ~ 0.8V.

 Overload protection: 600V

5. Capacitance

Range	Resolution	Accuracy
6.000nF	1pF	REL mode:±(4%+8)
60.00nF~600.0μF	10pF~0.1μF	±(3%+5)
6.000mF~60.00mF	1μF~10μF	±10%

⚠ Overload protection: 600V

When measuring capacitance $\leq 1\mu\text{F}$, it is recommended to select the REL mode to ensure accuracy.

6. Frequency/Duty cycle

Range	Resolution	Accuracy
10.00Hz~1.00MHz	0.01Hz~0.001MHz	±(0.1%+4)
0.1%~99.9%	0.1%	±(2%+5)

⚠ Overload protection: 600V

Input amplitude a: (DC level=0)

$\leq 100\text{kHz}$: $200\text{mVrms} \leq a \leq 30\text{Vrms}$

$> 100\text{kHz} \sim 1\text{MHz}$: $600\text{mVrms} \leq a \leq 30\text{Vrms}$

Duty cycle: Waveform must be square wave and frequency $\leq 10\text{kHz}$. Amplitude:

$1\text{Vpp} \leq \text{Input amplitude} \leq 30\text{Vpp}$

Frequency $\leq 1\text{kHz}$, duty cycle: 10.0%~95.0%

Frequency $> 1\text{kHz}$, duty cycle: 30.0%~70.0%

7. Temperature (UT191T)

Range		Resolution	Accuracy	
°C	-40~400°C	-40~300°C	0.1°C~1°C	±(1.0%+2°C)
		300~400°C		±(1.0%+2°C)
°F	-40~752°F	-40~572°F	0.2°F~2°F	±(1.0%+4°F)
		572~752°F		±(1.0%+4°F)

⚠ Overload protection: 600V

K-type thermocouple is only applicable for temperature less than 400°C/752°F.

8. DC current

Range		Resolution	Accuracy
μA	600.0μA	0.1μA	±(0.8%+3)
	6000μA	1μA	
mA	60.00mA	10μA	
	600.0mA	0.1mA	
A	6.000A	1mA	±(1.0%+3)
	20.00A	10mA	±(1.2%+5)

Warning: Please do not measure current above 10A for more than 30s. Cool down the device for twice the measurement time for another measurement.

⚠ Overload protection:

μA mA range: F1 Fuse (φ6×32) mm FF 600mA H 600V (CE)

20A range: F2 Fuse (φ10×38) mm FF 11A H 1000V (CE)

9. AC current

	Range	Resolution	Accuracy	
μA	600.0μA	0.1μA	± (1.0%+3)	
	6000μA	1μA		
mA	60.00mA	10μA		
	600.0mA	0.1mA		
A	6.000A	1mA		± (1.2%+3)
	20.00A	10mA		± (1.5%+5)

⚠ Warning: Please do not measure current above 10A for more than 30s. Cool down the device for twice the measurement time for another measurement.

Frequency response: 40~400Hz

Display: true RMS

Accuracy guarantee range: 1 -100% of the range, shorted circuit allows least significant digit ≤2

Non-sine wave:

Crest factor of 1.0 ~ 2.0, accuracy must be increased by 3.0%

Crest factor of 2.0 ~ 2.5, accuracy must be increased by 5.0%

Crest factor of 2.5 ~ 3.0, accuracy must be increased by 7.0%

⚠ Overload protection: (similar to DC current)

10. Peak value

Function	Response time	Accuracy	Remark
ACV	1ms	± (2%+100)	Display positive and negative peak value of AC signal.
ACA	1ms	± (3%+100)	

XI. Maintenance

⚠ Warning: Before opening the rear cover, switch off the power supply (remove test leads from the input terminal and the circuit).

1. General maintenance

- 1) Clean the case with a damp cloth and detergent. Do not use abrasives or solvents
- 2) If there is any malfunction, stop using the device and send it to maintenance.
- 3) The maintenance and service must be implemented by qualified professionals or designated departments.

2. Replacements

Battery replacement:

To avoid false reading, replace the battery when the battery indicator  appears.

Battery Specification: 9V DC battery (6F22, 1604A or 6LR61 type)

- 1) Switch the dial to "OFF" position and remove the test leads from the input terminal.
- 2) Take off the protective case. Loosen the 5 screws on battery cover; remove the cover to replace the battery. Please identify the positive and negative pole.

Fuse replacement:

- 1) Follow the battery replacement steps to replace the blown fuse F1:
F1 Fuse ($\phi 6 \times 32$)mm FF 600mA H 600V (CE)
- 2) To replace the F2 fuse, you need to loose 6 screws on the rear cover, and then remove the cover to replace:
F2 Fuse ($\phi 10 \times 38$)mm FF 11A H 1000V (CE)

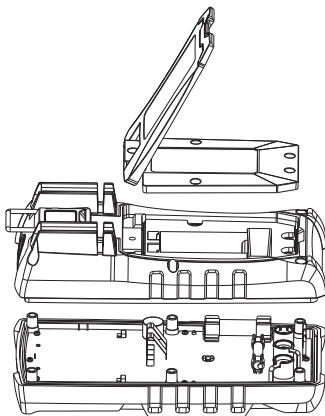

Uni-Trend reserves the right to update the content of this manual without further notice.

UNI-T
UNI-TREND TECHNOLOGY (CHINA) CO., LTD.

No6, Gong Ye Bei 1st Road,
Songshan Lake National High-Tech Industrial
Development Zone, Dongguan City,
Guangdong Province, China
Tel: (86-769) 8572 3888
<http://www.uni-trend.com>



Certificate No. QAC0956661